

## X2Rail-5

Project Title:	Completion of activities for Adaptable Communication, Moving Block, Fail Safe Train Localisation (including satellite), Zero on site Testing, Formal Methods and Cyber Security
Starting date:	01/12/2020
Duration in months:	30
Call (part) identifier:	S2R-CFM-IP2-01-2020
Grant agreement no:	101014520

### Deliverable D4.1

### Moving Block Specification

### Part 3 – System Specification

Due date of deliverable	Month 24
Actual submission date	21-Dec-2022
Organization name of lead contractor for this deliverable	SMO
Dissemination level	PU
Revision	Final

## Version Management

The Version history below refers to Part 3 of Deliverable D4. 1.

Version Management		
Version Number	Modification Date	Description / Modification
01	26-Feb-21	Import from X2Rail-3 D4.2, no changes
02	26-Feb-21	Changes from X2Rail-3 leftover changes. Change sheet _X2R3_Open_Points, sheet ““minor changes”
03	22-Apr-21	Changes after reviewer’s comments
04	27-Apr-21	Change X2Rail-1 tags to X2Rail-3 tags, renumber
05	05-May-21	Additional changes after replies from reviewers.
06	26-May-21	Update for X2Rail-3 Train Location Open Points
07	07-Jun-21 24-Jun-21	Update to replace section 2.2 with version from Routes workshop and comments on Train Location
08	13-Jul-21	Update for Open Points relating to Points and TTDs
09	26-Jul-21	Update for Open Points relating to Shunting
10	27-Jul-21	Correction of mistake when uploading Version 09
11	12-Aug-21	Other updates following Author+Reviewer meetings
12	06-Oct-21	Changes following Authors+Reviewers meetings <ul style="list-style-type: none"> <li>• Points Proposal (section 3.6)</li> <li>• Reversing Paper (section 3.14)</li> </ul>
13	12-Nov-21	Update after review of V12 by Authors+Reviewers, and updated requirements for: <ul style="list-style-type: none"> <li>• Reserved (section 3.3)</li> <li>• Movement Authorities (section 3.7)</li> </ul>
14	30-Nov-21	Update after review of V13 by Authors+Reviewers, and for remaining X2Rail-3 Open Points
15	30-Nov-21	Clean version of V14, for WP4 review
16	02-Sep-22	Updated for “Simple” X2R5 Open Points
17	25-Oct-22	Re-incorporated updated sections for Train Location, Track Status and TTD requirements. Updated for remaining X2R5 Open Points.
18	18-Nov-22	Updated after first WP4 Review
19	25-Nov-22	Version for TMT/SC review
20	25-Nov-22	Clean version for TMT/SC review
21	20-Dec-22	Updated after TMT/SC review and further WP4 review
22	21-Dec-22	Clean version of 21
23	21-Dec-22	PDF version of 22

## Table of Contents

---

<b>TABLE OF CONTENTS.....</b>	<b>3</b>
<b>TABLE OF FIGURES.....</b>	<b>4</b>
<b>TABLE OF TABLES .....</b>	<b>6</b>
<b>1 BACKGROUND.....</b>	<b>7</b>
<b>2 SYSTEM CONTEXT.....</b>	<b>8</b>
2.1 Scope.....	8
2.2 Track State.....	8
2.3 Margin.....	21
2.4 Propagation.....	23
<b>3 SYSTEM REQUIREMENTS.....</b>	<b>24</b>
3.1 Train location.....	25
3.2 Track Status .....	37
3.3 Reserved Status.....	59
3.4 Fixed Virtual Blocks .....	68
3.5 Trackside Train Detection.....	70
3.6 Points Control.....	83
3.7 Movement Authorities .....	91
3.8 EoA Exclusion Area.....	98
3.9 Start of Mission.....	101
3.10 SR Movement.....	105
3.11 Loss of Communication.....	108
3.12 Recovery management after loss of communication .....	110
3.13 Radio Hole.....	114
3.14 Reversing.....	118
3.15 End of Mission.....	122
3.16 Loss of Train Integrity.....	123
3.17 Level Transition.....	128
3.18 Trackside Initialisation.....	130
3.19 Handover.....	132
3.20 Shunting movement.....	134
3.21 Traffic Management System interface.....	139

## Table of Figures

Figure 1: Track State components .....	8
Figure 2: Key to diagrams.....	9
Figure 3: MA shorter than Reserved Status Area.....	11
Figure 4: Short Reserved Status Area remaining.....	11
Figure 5: Short Reserved Status Area extended.....	11
Figure 6: Full Moving Block Track Status and Reserved Status Areas for a train .....	12
Figure 7: Full Moving Block Track Status, Reserved Status Areas and Train Location symbol.....	12
Figure 8: Fixed Virtual Block Track Status and Reserved Status Areas for a train.....	13
Figure 9: Fixed Virtual Blocks Track Status, Reserved Status Areas and Train Location symbol.....	13
Figure 10: Full Moving Block consolidated Track Status .....	18
Figure 11: Fixed Virtual Block Consolidated Track Status .....	18
Figure 12: One Train Following Another – Full Moving Block.....	21
Figure 13: One Train Following Another – Fixed Virtual Blocks.....	21
Figure 14: Use of L3 Margin.....	22
Figure 15: Terms used for Train Location.....	25
Figure 16: Train Location from Start of Mission Train Position Report.....	28
Figure 17: Train Location when receiving Validated Train Data during Start of Mission.....	30
Figure 18: Train Location when receiving Validated Train Data, L_TRAIN decreased.....	31
Figure 19: Train Location when receiving Validated Train Data, L_TRAIN increased.....	32
Figure 20: Front of Train Location updated from new Train Position Report.....	33
Figure 21: Rear of Train Location updated from new Train Position Report, Integrity Confirmed .....	34
Figure 22: Unknown Track Status Area adjusted for the created Train Location .....	40
Figure 23: Unknown Track Status Area created from Train Location at Start of Mission.....	41
Figure 24: Track Status Area created from Train Location when train enters L3 Area.....	42
Figure 25: Track Status Area updated from Train Location .....	42
Figure 26: Occupied Track Status Area after confirmation of Train Integrity .....	44
Figure 27: Unknown Track Status Area remains when Front Train after Splitting leaves .....	46
Figure 28: Unknown Track Status Area created after integrity confirmed by Driver .....	48
Figure 29: Train with Train Integrity confirmed Sweeping an Unknown Track Status Area.....	49
Figure 30: Train without Train Integrity Confirmed Sweeping an Unknown Track Status Area.....	50
Figure 31: Existing Unknown Track Status Area swept by a passing train .....	50
Figure 32: New Unknown Track Status Area swept by a passing train .....	51
Figure 33: Short unknown area at crossover.....	53
Figure 34: Reserved Status Area to the target location, including an overlap .....	61
Figure 35: Reserved Status Area to the rear of a train in front .....	61
Figure 36: Reserved Status Area to FVB border boundary.....	61
Figure 37: Reserved Status Area for Train 1 to join with Train 2.....	61
Figure 38: Reserved Status Area for Train 1 to join with Train 2 with FVB .....	62
Figure 39: Reserved Status Area extended to the target location after Train 2 has left .....	64
Figure 40: Reserved Status Area update after a new Train Position Report .....	66
Figure 41: Consolidated Track Status Occupied mapped to Fixed Virtual Block Status.....	69
Figure 42: Consolidated Track Status Unknown mapped to Fixed Virtual Block Status.....	69
Figure 43: Fixed Virtual Blocks with TTD.....	70
Figure 44: Shortening of front of Train Location due to clear TTD .....	72
Figure 45: No shortening of front of Train Location due to clear TTD .....	73
Figure 46: Shortening of rear of Train Location due to clear TTD .....	74
Figure 47: No shortening of rear of Train Location due to clear TTD .....	74
Figure 48 Extension of Unknown after Mute Timer has expired by Occupied TTD .....	76
Figure 49: Extension of Train Location within Radio Hole by Occupied TTD .....	77
Figure 50: Creation of Unknown Track Status Area for unexpected Clear TTD.....	81
Figure 51: Shortening of rear of Reserved Status Area due to clear TTD .....	82
Figure 52: Shortening of rear of Reserved Status Area due to Occupied TTD in Radio Hole .....	83
Figure 53: Locking Area for Points in Full Moving Block .....	84
Figure 54: Locking Area for Crossing in Full Moving Block.....	85
Figure 55: Sweeping Area for Points in Full Moving Block.....	86
Figure 56: Sweeping Area for Crossing in Full Moving Block.....	86
Figure 57: Passage of Sweeping train across Points – Sweeping Point at Fouling Point.....	89
Figure 58: Passage of Sweeping train across Points – to Release Point.....	90
Figure 59: EoA with engineered D_DP, Full Moving Block .....	92

---

Figure 60: EoA with engineered D_DP, Fixed Virtual Blocks .....	92
Figure 61: EoA with L3 Margin for D_DP, Full Moving Block .....	92
Figure 62: EoA with L3 Margin for D_DP, Fixed Virtual Blocks .....	93
Figure 63: L3 Margin before start of OS Mode Profile, Full Moving Block .....	94
Figure 64: L3 Margin before start of OS Mode Profile, Fixed Virtual Blocks .....	94
Figure 65: OS Mode Profile for crossing Unknown Track Status Area.....	94
Figure 66: Example of an EoA Exclusion Area.....	100
Figure 67: SR Authorisation up to the end of an Unknown area.....	105
Figure 68: Unknown to Clear and Occupied following reconnection of communications.....	113
Figure 69: Unknown Area after expiry of Radio Hole Timer.....	117
Figure 70: Area to protect for a reversing train.....	119
Figure 71: Update of the Track Status Area following a train reporting in RV mode.....	120
Figure 72: Mute Timer Expiry for a train that has received Reversing Area Information.....	121

## Table of Tables

---

Table 1 – Track Status Area Occupied Reasons .....	14
Table 2 – Track Status Area Unknown Reasons .....	15
Table 3 – Inputs for Track Status Areas .....	18
Table 4 – Data Stored for Track Status Areas.....	19
Table 5 - Reserved Status Area Reasons .....	20
Table 6 - Reserved Status Area Functions .....	20
Table 7 – Data Stored for Reserved Status Areas .....	21
Table 8 – Structure of Requirements .....	24
Table 9 – Track Status Area Stored Data.....	58
Table 10: TMS associated requirements.....	140

# 1 Background

---

This document is Part 3 of Deliverable D4.1 “Moving Block Specifications” from the Project titled “Completion of activities for Adaptable Communication, Moving Block, Fail Safe Train Localisation (including satellite), Zero on site Testing, Formal Methods and Cyber Security” (Project Acronym: X2Rail-5; Grant Agreement No 101014250).

Deliverable D4.1 is made up of several different parts. This is Part 3 – System Specification. See Part 1 – Introduction for a list of the different Parts of this Deliverable.

All terms and abbreviations, and all references for all parts of D4.1 are located in Part 1 – Introduction.

This part contains requirements for the ETCS Level 3 System. Most of these requirements are for the L3 Trackside.

## 2 System Context

### 2.1 Scope

The scope of D4.1 is defined in Part 2 System Definition. This section provides an introduction to specific topics which are important to understand the Requirements contained within Part 3.

### 2.2 Track State

#### 2.2.1 Introduction

An important feature of ETCS Level 3 is that the Track State is determined primarily based on Train Position Reports, compared with Trackside Train Detection (TTD) in traditional signalling systems and systems based on ETCS Level 1 or 2.

The L3 Trackside needs to have accurate and up to date information about the Track State for its complete Area of Control, in order to be able to authorise train movements in a safe way.

In order to achieve this, the L3 Trackside will need to store information regarding Track State. For example, if a train changes to SB mode, and therefore stops communicating with the L3 Trackside, the train is still present and still represents an obstruction on the railway.

A corollary of the above is that there must also be Operational Rules which prevent the movement of non-communicating railway vehicles without protection being in place within the L3 Trackside, unless the system is specifically engineered to be used by non-communicating trains, for example by using Trackside Train Detection.

The Track State is made up of Track Status and Reserved Status. The relationships are shown in Figure 1 below, with further descriptions in following subsections:

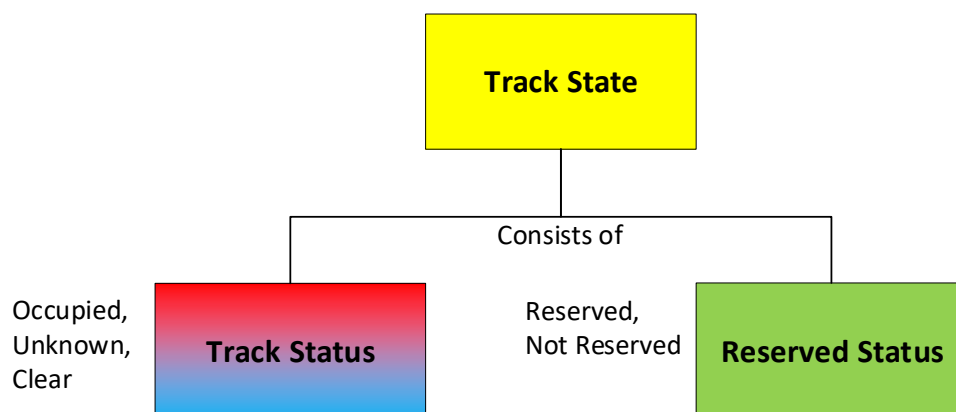


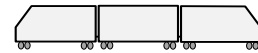
Figure 1: Track State components



A number of diagrams are used to explain the functionality of the L3 Trackside in this deliverable, Figure 2 gives a key to the symbols used:

**Real Trains:**

Symbol used to represent a real train, to show difference between real train and L3 Trackside representation



**L3 Trackside view of Trains:**

Communicating train, with Train Integrity Confirmed.  
Rear of front triangle shows Estimated Front End.  
Tip of front triangle shows Max Safe Front End.  
Rear is Confirmed Rear End.



Communicating train, with Train Integrity Confirmed.  
Dotted line near front shows Min Safe Front End. Only shown when relevant.



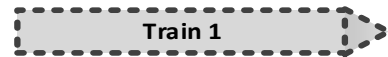
Communicating train, without Train Integrity Confirmed.  
Rear is previous CRE, as reported before loss of Train Integrity.



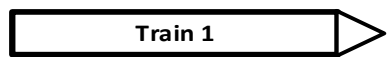
Train after End of Mission.  
Train is shown at last reported position.



Train after loss of communications.  
Train is shown at last reported position.  
Tip of the triangle is the last reported Max Safe Front End.



Train Location after being adjusted by TTD



**Track Status Area**

Unknown section of track



Clear section of track



Overlapped Track Status



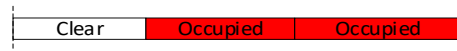
**Reserved Status Area**

Area of track reserved for a train to move



**Track Elements**

FVB status



TTDs



TTD Boundary

TTD Boundary



**Steps:**

Steps between different states within one diagram. Number as used in commentary.

**Figure 2: Key to diagrams**

## 2.2.2 Track Status and Reserved Status

The Track State is made up of two components:

### 1. Track Status

This represents the information held within the L3 Trackside about the status of an area of the track. Any area of the track within the L3 Trackside Area of Control can be:

- **Occupied** The L3 Trackside considers that there is a known obstacle on the track consisting of a communicating train with Train Integrity confirmed.
- **Clear** The L3 Trackside considers that there are no obstacles present on the track.
- **Unknown** The L3 Trackside is unsure whether there is a train or obstacle present on the track, or sure that there is a train, but does not know the exact location of the train within the Unknown area.

Track Status is represented in this document by using discrete Track Status Areas. An individual Track Status Area is for a specific reason, such as a reporting train, or an area of Unknown created by the TMS. Each Track Status Area can be Occupied or Unknown. The individual Track Status Areas can overlap and are then superimposed to create the Consolidated Track Status, which can be Occupied, Unknown or Clear. For more details see section 2.2.5.

### 2. Reserved Status

This represents the information held within the L3 Trackside about whether track is reserved for a train movement or not. If any part of the track within the L3 Trackside Area of Control is reserved for a train movement the Reserved Status is Reserved.

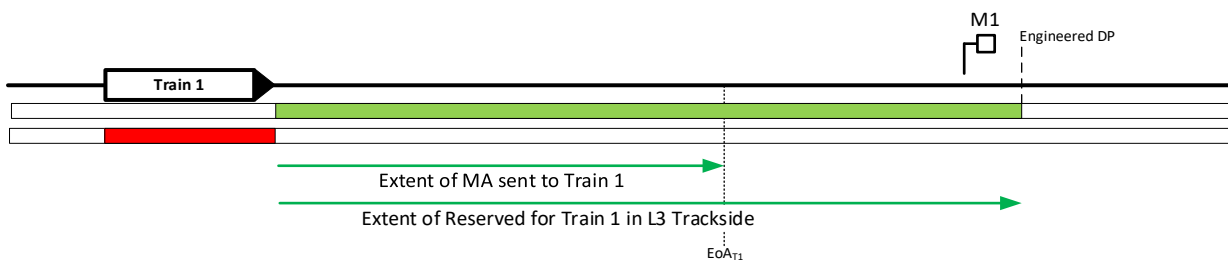
Reserved Status is represented in this document by using discrete Reserved Status Areas. An individual Reserved Status Area is allocated to a specific train to travel in a specific direction, even if the Train ID is not yet known by the L3 Trackside, for example for transitions into the L3 Trackside Area of Control. For more details see section 2.2.7.

Track Status and Reserved Status are independently determined by the L3 Trackside.

- Track Status is determined from Train Position Reports, together with other inputs from the TMS, and from TTD if TTD is used.
- Reserved Status is determined in response to a request to permit a train to move or if there is a need to extend or shorten a path assigned to a train.

A Reserved Status Area must exist and be allocated to a train before authorisation is sent to a train.

In this document, the MA for a train is assumed to go to the end of the Reserved Status Area allocated to the train. In practice, for example because of limitations in the size of MAs, the MA may not extend to the end of the Reserved Status Area. This is shown in Figure 3 below.



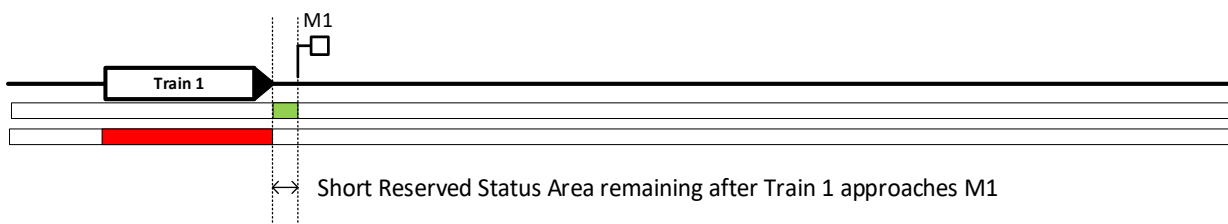
**Figure 3: MA shorter than Reserved Status Area**

Within this document, the Reserved Status Areas are typically shown as ending at a Marker Board, so without an overlap, and without an engineered Danger Point.

Reserved Status is described here without reference to Routes, because the concept of Routes is not consistent across different railways, different suppliers. This approach also aims to permit differing implementations.

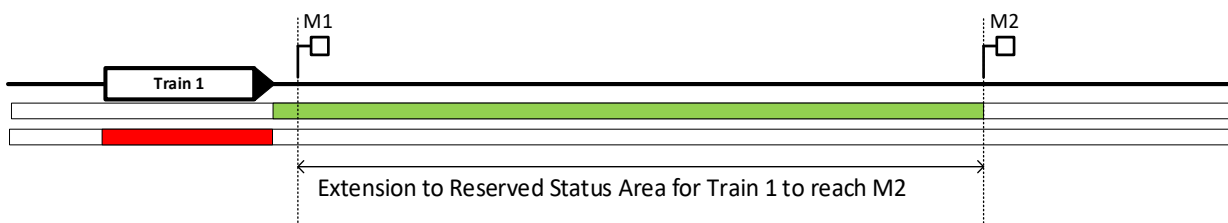
- The L3 Trackside could be implemented for use with a traditional “Route Setting” approach, in which case Reserved Status Areas are created or extended in response to Routes being set by the Traffic Management System
- The L3 Trackside could be implemented for use with a Traffic Management System which requests a path for trains to move, without the concept of Routes being used within the L3 Trackside

After stopping at the end of a Reserved Status Area, there is likely to be a short part of the Reserved Status Area remaining:



**Figure 4: Short Reserved Status Area remaining**

This short Reserved Status Area will be extended if the train is to be given a further Movement Authority:



**Figure 5: Short Reserved Status Area extended**

### 2.2.3 Track Status and Reserved Status in Full Moving Block

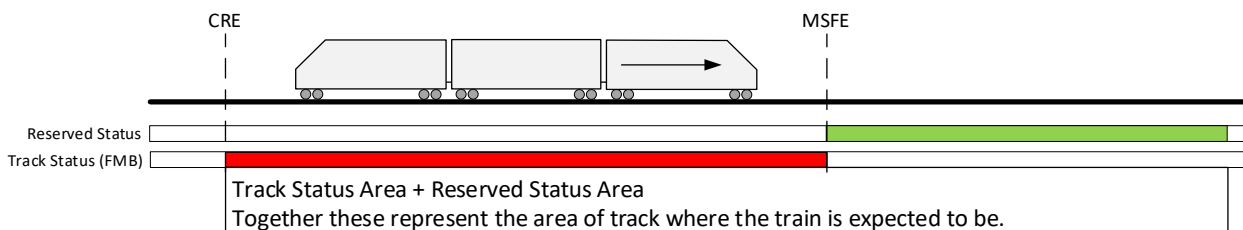
In a system using Full Moving Block (FMB), for a train reporting Train Integrity confirmed:

- The Track Status Area for a train is from the Maximum Safe Front End (MSFE) of the train to the Confirmed Rear End (CRE) of the train.
- In systems using TTD, the Train Location (see 3.1) may be shortened by clear TTD at the front and/or the rear of the train.
- If a Reserved Status Area is not yet allocated to a train, it will start and end as for the path requested by the TMS.
- If a Reserved Status Area is allocated to a train, it will be from the front of the Train Location for the train to which it is allocated, to the end of the path requested by the TMS.

The Train Location for a train represents the L3 Trackside interpretation of where the train is within the track. The Track Status Area for a train is a representation of the Train Location. Depending on the frequency of Train Position Reports, the rear end of this Track Status Area might be far from where the rear end of the train is, while the front end is updated with every position report.

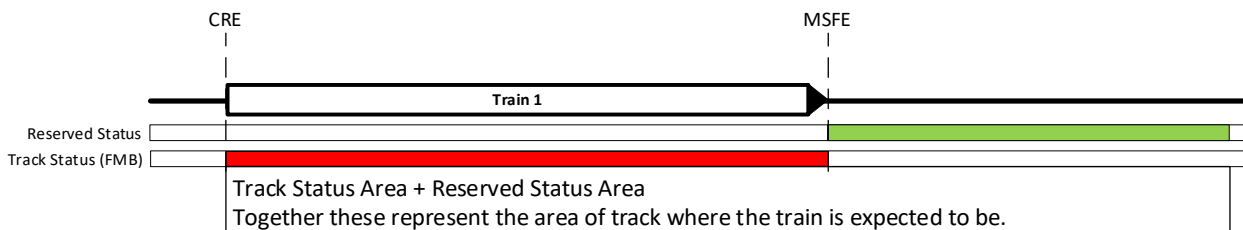
The Reserved Status Area for a train represents the area reserved for the train within the L3 Trackside.

Together, the Track Status Area and the Reserved Status Area represent the area of the railway where a train is expected to be, as shown in Figure 6:



**Figure 6: Full Moving Block Track Status and Reserved Status Areas for a train**

Within the remainder of this document, the representation of the real train is not shown. Instead, the L3 Trackside interpretation used is as shown in Figure 7:



**Figure 7: Full Moving Block Track Status, Reserved Status Areas and Train Location symbol**

The rear of the Reserved Status Area will be at the front of the Track Status Area associated with that train, as shown in Figure 7.

The Track Status Area associated with a train could be Occupied, as shown in Figure 7, or could be Unknown, for example if the train has lost Train Integrity.

### 2.2.4 Track Status and Reserved Status in Fixed Virtual Blocks

In a system using Fixed Virtual Blocks (FVB), each Fixed Virtual Block has a status Occupied, Unknown or Clear. Track Status is mapped on to Fixed Virtual Blocks.

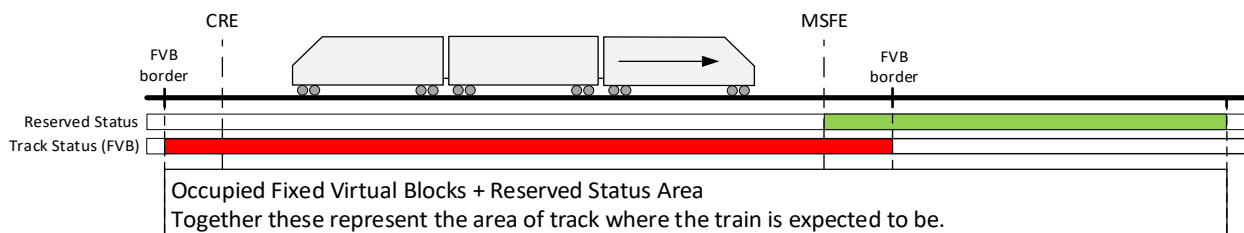
- The Fixed Virtual Blocks with status “Occupied” for a train are the Fixed Virtual Block containing the Maximum Safe Front End (MSFE) of the train, all Fixed Virtual Blocks entirely within the Train Location, and the Fixed Virtual Block containing the Confirmed Rear End (CRE) of the train.
- In systems using TTD, the Train Location may be shortened by clear TTD at the front or the rear of the train.

The Occupied Fixed Virtual Blocks for a train represent the area that the train was known to be within at the time of the most recent Train Position Report. The area is larger than the train because the granularity of the Fixed Virtual Blocks. Depending on the frequency of Train Position Reports, the rear end of this area might be far from where the rear end of the train is, while the front end is updated with every position report..

The Reserved Status Area allocated to a train represents the area reserved for the train within the L3 Trackside.

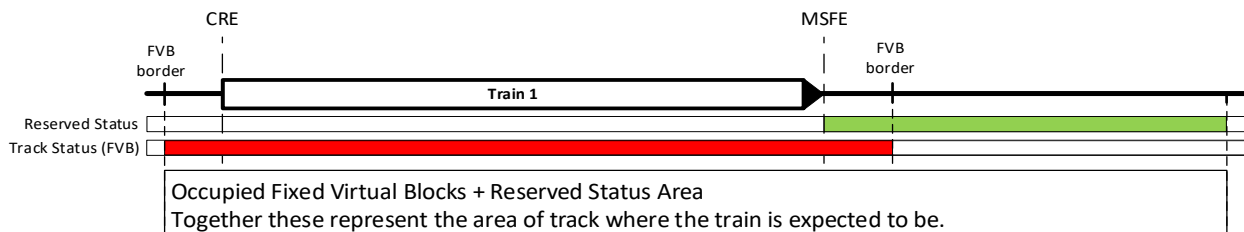
Reserved Status is not mapped on to Fixed Virtual Blocks. The rear of the Reserved Status Area allocated to train will be at the Max Safe Front End of the train. As a result, there will be an overlap between the Fixed Virtual Blocks with Status “Occupied” for a train, and the Reserved Status Area allocated to a train.

Together, the Occupied Fixed Virtual Blocks and the Reserved Status Area represent the area of the railway where a train is expected to be, as shown in Figure 8:



**Figure 8: Fixed Virtual Block Track Status and Reserved Status Areas for a train**

Within the remainder of this document, the representation of the real train is not shown unless needed for clarity. Instead, the L3 Trackside interpretation used is as shown in Figure 9:



**Figure 9: Fixed Virtual Blocks Track Status, Reserved Status Areas and Train Location symbol**

The Status of the Fixed Virtual Blocks could be Occupied, as shown, or could be Unknown, for example if the train has lost Train Integrity.

## 2.2.5 Determination of Track Status

Track Status can be considered as a collection of Track Status Areas, each of which can be Occupied or Unknown. Track Status Areas can overlap, and therefore the individual Track Status Areas are superimposed to create the Consolidated Track Status, which can be Occupied, Unknown or Clear. Any area of track which is not covered by a Track Status Area, Occupied or Unknown, is Clear.

An Occupied Track Status Area is always for a specific train. An Unknown Track Status Area may be for a specific train, but may also exist for another reason, not associated with a specific train, such as an Unknown Track Status Area created by the Dispatcher, or an Unknown Track Status Area corresponding to an Activated Temporary Shunting Area. An Unknown Track Status Area created by the Dispatcher can be Sweepable or Non-Sweepable.

There is only one reason for an Occupied Track Status Area, as shown in Table 1:

Track Status Area Occupied Reason	Notes	Section(s) for Requirements
Reporting train with Train Integrity confirmed	L3 Trackside has established the Train Location for this train, and Train Integrity has not been considered lost since the last time it was confirmed by an external device (TIMS).	Section 3.1 Section 3.2

**Table 1 – Track Status Area Occupied Reasons**

There are several reasons for an Unknown Track Status Area, as shown in Table 2:

Track Status Area Unknown Reasons	Notes	Section(s) for Requirements
Reporting train which has never confirmed Train Integrity	L3 Trackside is receiving Train Position Reports, but the train has never reported Train integrity confirmed.	Section 3.1 Section 3.9
Reporting train with Train Integrity lost	L3 Trackside is receiving Train Position Reports, and the train has previously reported Train Integrity confirmed by external device. Since then, the train has reported Train Integrity lost, and has not subsequently reported Train Integrity confirmed.	Section 3.16
Reporting train with Integrity Wait Timer expired	L3 Trackside is receiving Train Position Reports, and the train has previously reported Train Integrity confirmed by external device. Since then, the train has reported Train Integrity not available for longer than the Integrity Wait Timer, so it is treated as Train Integrity Lost	Section 3.16

Track Status Area Unknown Reasons	Notes	Section(s) for Requirements
Reporting train with new value of L_TRAIN	L3 Trackside is receiving Train Position Reports, and has also received a new value of L_TRAIN. Since then, the train has not reported Train Integrity confirmed	Section 3.16
Train is no longer in communication	L3 Trackside was receiving Train Position Reports, but is no longer doing so, and so the train is treated as having lost communications	Section 3.11 Section 3.13
Train has performed EoM	L3 Trackside has received an EoM message	Section 3.15
Train reports in RV Mode	L3 Trackside has received a Train Position Report from a train reporting RV Mode	Section 3.14
Unknown area created via TMS	The Dispatcher has created an Unknown Track Status Area via the TMS. Can be Sweepable or Non-Sweepable	Section 3.2
Unknown Area created by L3 Trackside at Initialisation	At initialisation of the L3 Trackside, the complete Area of Control is Unknown	Section 0
Unexpected Occupied TTD	A TTD input is unexpectedly Occupied	Section 3.5
Active Shunting Area	All track within an Active Shunting Area is Unknown	Section 3.20

**Table 2 – Track Status Area Unknown Reasons**

The individual Track Status Areas can overlap with each other, and are created, updated, or removed according to several different inputs to the L3 Trackside. Table 3 summarises the main inputs and their effect:

Source of Input	Input	Effect	Section(s) for Requirements	Notes
Responsible Person	Confirms initialisation completed	Remove Unknown Area created at Initialisation	Section 0	Can be input via TMS

Source of Input	Input	Effect	Section(s) for Requirements	Notes
TMS	Create Unknown Area	Create Unknown Area	Sections 3.2 and 0	Can be Sweepable or Non-Sweepable
TMS	Update Unknown Area	Update Unknown Area	Section 3.2	Can extend or reduce Unknown Area
TMS	Remove Unknown Area	Remove Unknown Area	Section 3.2	
TMS	Activate Temporary Shunting Area	Create Unknown Area covering the Activated Shunting Area	Section 3.20	
TMS	Deactivate Temporary Shunting Area	Remove Unknown Area created for Activated Shunting Area	Section 3.20	
L3 Trackside	Radio Hole timer expired	Extend Track Status Area for train through Radio Hole, and change to Unknown	Section 3.13	A train within an Active Radio Hole for longer than the defined time is treated as for loss of communication
TMS	Authorised override of TTD	Remove Unknown which has been created because of an Occupied TTD without a corresponding Train Position Report.	Section 3.5	
Train	New Validated Train Data message	Potentially update Track Status Area for train	Section 3.2	A change in the value of L_TRAIN is treated as Loss of Train Integrity

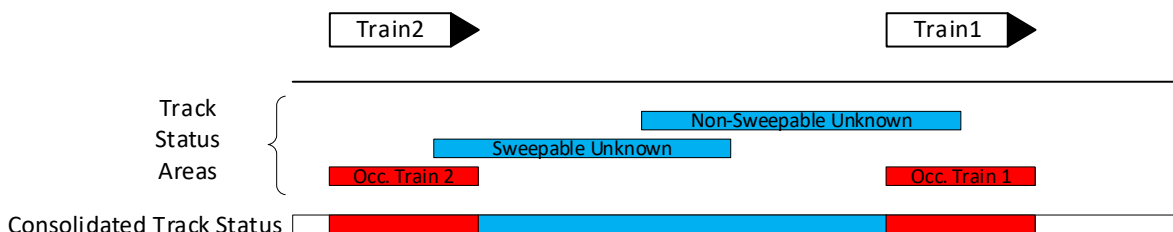


Source of Input	Input	Effect	Section(s) for Requirements	Notes
Train	Start of Mission Position Report	Potentially create or update Track Status Area for train	Section 3.2 Section 3.9	
Train	New Train Position Report	Update the Track Status Area associated with the train which reported its position and any Track Status Area(s) that could be swept by the recent movement of this train	Section 3.2	<ul style="list-style-type: none"> <li>• See Section 3.16 for rules around Loss of Train Integrity</li> <li>• New Train Position Report can “sweep” Unknown Track Status Areas from a different train.</li> </ul>
Train	EoM Train Position Report	Change Track Status Area associated with the reporting train to Unknown	Section 3.15	
L3 Trackside	Communications Timeout	Change Track Status Area associated with the reporting train to Unknown and extend it to cover any allocated Reserved Status Area, or that portion of it covering the MA issued to the train if the MA issued does not reach the end of the Reserved Status Area.	Section 3.11	Two levels of timeout, depending on if Communications Mute Timer is used.
TTD	TTD Changes Occupied to Clear	Reduce/remove the part of an existing Sweepable Track Status Area within a clear TTD section..	Section 3.5	If the change to Clear is unexpected, an Unknown Track Status Area can be created.

Source of Input	Input	Effect	Section(s) for Requirements	Notes
TTD	TTD Changes Clear to Occupied	If unexpected, create a new Unknown Track Status Area; if expected, extend the adjacent Track Status Area.	Section 3.5	
TMS	External device e.g. Landslide detector of fallen objects detector	Create an Unknown Track Status Area	Section 3.2	

**Table 3 – Inputs for Track Status Areas**

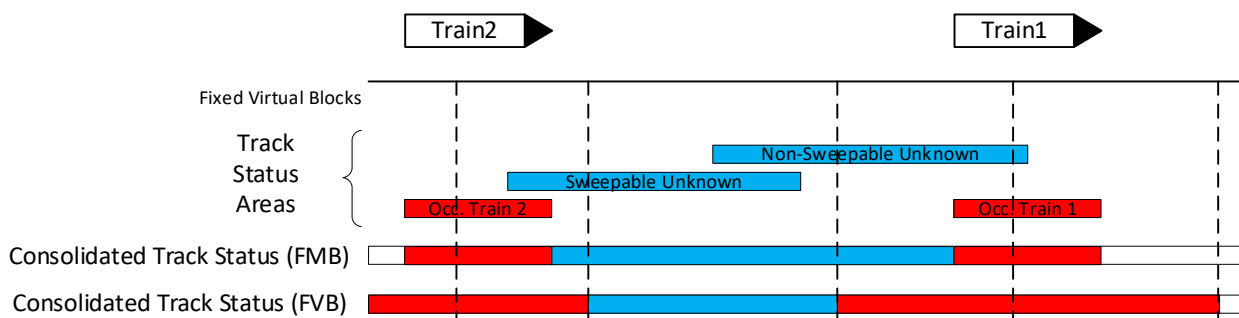
The L3 Trackside will use rules to create a Consolidated Track Status which takes account of the overlapping Track Status Areas created from different sources. Occupied has precedence over Unknown. This is shown in Figure 10:



**Figure 10: Full Moving Block consolidated Track Status**

The requirements to create the Consolidated Track Status are in section 3.2.

If Fixed Virtual Blocks are used, the L3 Trackside will use rules to map the consolidated Track Status onto the Fixed Virtual Blocks. This is shown in Figure 11:



**Figure 11: Fixed Virtual Block Consolidated Track Status**

The requirements to map Track Status onto Fixed Virtual Blocks are in section 3.4.

## 2.2.6 Data Stored for Track Status Areas

The L3 Trackside will store data for each Track Status Area as in Table 4:

Data Item	Type or Possible Values	Notes
Status	Occupied, Unknown	Clear areas of track are where there are no areas of Occupied or Unknown
Extent	Definition of the extent of the Track Status Area	The extent of the Track Status Area.
Train Length	As for L_TRAIN	The length of train associated with this area, if any. Note this is not the same as the length of the Extent of the Track Status Area.
ETCS Train ID	As for NID_ENGINE	The NID_ENGINE of train associated with this Track Status Area, if any.
Reason Unknown	List of possible reasons for Unknown	The reason for the Unknown Track Status Area, if the Status is Unknown. See Table 2.
Sweepable	Boolean	Whether an Unknown Track Status Area is Sweepable or Non-Sweepable.

**Table 4 – Data Stored for Track Status Areas**

## 2.2.7 Determination of Reserved Status

Reserved Status can be considered as a collection of Reserved Status Areas. The L3 Trackside can allocate a Reserved Status Area to a specific train. However, the Train ID may not yet be known, e.g. when preparing for a train to enter the L3 area.

Reserved Status Areas do not overlap except where operationally required.

Any area of track which is not covered by a Reserved Status Area is Not Reserved.

The reasons for a Reserved Status Area to exist are listed in Table 5:

Reserved Status Area Reasons	Notes	Section(s) for Requirements
On Request from the TMS, the L3 Trackside will issue a new or extended Movement Authority to a train	<p>Can include an On-Sight Mode Profile, which can overlap Track Status Areas which are Unknown or Occupied.</p> <p>The L3 Trackside may also extend a Reserved Status Area when one train is following another, if implemented.</p> <p>The L3 Trackside can extend the MA if it is not already at the end of the Reserved Status Area.</p>	Section 3.3 Section 3.7

Reserved Status Area Reasons	Notes	Section(s) for Requirements
On Request from the TMS, the L3 Trackside may create or extend a train	For a train with an approximate position supplied via the TMS.	Section 3.3 Section 3.10
On Request from the TMS, the L3 Trackside may create or extended Movement Authority to a train	For a non-communicating train, which can overlap Track Status Areas which <ul style="list-style-type: none"> <li>has not yet entered the L3 area</li> </ul>	Section 3.3 Section 3.7

**Table 5 - Reserved Status Area Reasons**

The individual Reserved Status Areas can overlap Track Status Areas which are Unknown or Occupied.

Reserved Status Areas are created or extended in response to a request to permit a train to move, for example if a request is received from the Traffic Management System, or an MA Request is received from a train for which a path is defined, for example when one train is following another. Reserved Status Areas can be reduced following a request to shorten an authorisation, for example if there is a co-operative shortening of a Movement Authority. Table 6 summarises the Reserved Status Area functions:

Reserved Status Area Function	Section(s) for Requirements	Notes
Create new Reserved Status Area	Section 3.3	Required for MA, or to give SR Authorisation
Update start of existing Reserved Status Area	Section 3.3 Section 3.5	The start of the Reserved Status Area is updated when a new Train Position Report is received. The start of the Reserved Status Area can also be updated by TTD.
Update front of existing Reserved Status Area	Section 3.3	Reserved Status Area can be extended as required. This could be up to the next obstruction.
Update front of existing Reserved Status Area	Section 3.3	Reserved Status Area can be reduced e.g. if an MA is shortened to re-route the train.
Remove existing Reserved Status Area	Section 3.3 Section 3.11 Section 3.15	Applies at EoM, and after loss of communication if the ETCS session is lost. May also apply if a train is re-routed.

**Table 6 - Reserved Status Area Functions**

### 2.2.8 Data Stored for Reserved Status Areas

The L3 Trackside will store data for each Reserved Status Area as in Table 7:

Data Item	Type or Possible Values	Notes
Extent	Definition of the extent of the Reserved Status Area	The extent of the Reserved Status Area, consisting of a start point, an end point, and the path from start point to end point in the intended travel direction.
ETCS Train ID	As for NID_ENGINE	The NID_ENGINE of the train to which the Reserved Status Area is allocated, if any.

**Table 7 – Data Stored for Reserved Status Areas**

### 2.3 Margin

Within a Moving Block Signalling System, it is a key objective that one train may follow another. The Movement Authority for a following train can be up to the rear of the preceding train:



**Figure 12: One Train Following Another – Full Moving Block**

This also applies within a Fixed Virtual Block system, where the Movement Authority for a following train can be up to the boundary of the Fixed Virtual Block occupied by a preceding train:

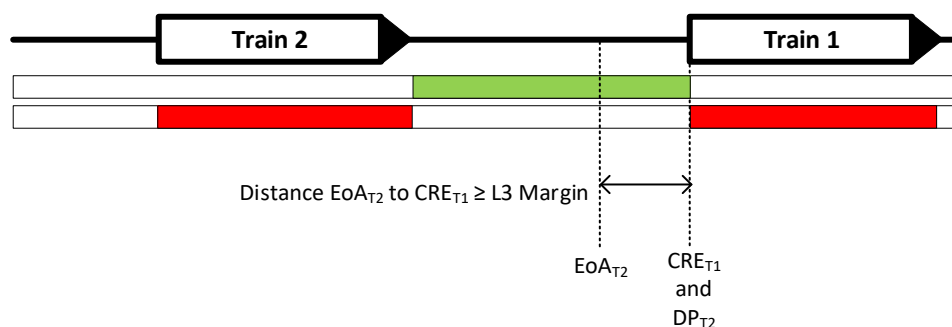


**Figure 13: One Train Following Another – Fixed Virtual Blocks**

It is necessary to ensure that the risk of collision is sufficiently mitigated, including if the preceding train is stopped, or even rolling backwards.

The requirements in section 3.7 regarding the issuing of Movement Authorities make use of the concept of an “L3 Margin”. This will be a distance defined when the system is engineered, and then used by the L3 Trackside when issuing Movement Authorities.

In the case where one train is following another, the L3 Margin will be used within the L3 Trackside as in Figure 14:



**Figure 14: Use of L3 Margin**

The principle for use of the L3 Margin shown in Figure 14 is also applied for a system using Fixed Virtual Blocks. The DP for Train 2 will be at a FVB boundary.

The ETCS supervision prevents trains from overpassing their Supervised Location; in the figure it is the Danger Point, DP. Having the EOA and the DP separated with at least the L3 Margin reduces the risk of collision, but it is not fully mitigated. However, for there to be a collision, two failures are required:

- 1) Train 1 is rolling or has rolled backwards and overpassed the CRE
- 2) Train 2 overpasses the End of Authority given in its Movement Authority

As long as both trains are moving forward the first failure will not happen and the second is less likely to happen when authorisations are continuously updated. But the risk for collision increases when the first train has stopped, because then both failures are possible. Even if both occur, the trains may not collide depending on how far they go beyond the EoA/CRE and if this is in total more than the L3 Margin.

There are additional mitigations:

- 1) The Movement Authority can instead be given with the DP at the End of Authority, i.e. at the same location in rear of the CRE, which prevents the train from overpassing its End of Authority.
- 2) If Train 1 is a reporting train, as shown, then it will send Train Position Reports indicating that it has moved backwards into the Movement Authority of Train 2. The L3 Trackside must react to this situation, for example by shortening the Movement Authority of Train 2.

When authorising a train to follow another train, the Movement Authority can be given with or without a Release Speed. In normal Moving Block operation with both trains moving, a Release Speed may not be needed, but if a train is supposed to be able to approach close to the train in front, e.g. when stopping at a platform, in parking areas or at a station entrance during peak traffic, a Release Speed is often needed to reach the EoA.

There is an Engineering Rule in Part 5, which requires that the value of L3 Margin is engineered. There is associated Guidance with that Engineering Rule.

## 2.4 Propagation

The concept of propagation is based on the idea that an area of track with Unknown Track Status may need to be increased, possibly after a period of time, to allow for the fact that any railway vehicles in the area which is Unknown may move without knowledge of the L3 Trackside system.

Within a traditional signalling system, with 100% Trackside Train Detection (TTD), any movement which crosses a TTD boundary is likely to be detected. Without TTD, movements of non-reporting rail vehicles will not be detected by the L3 Trackside.

For stationary vehicles, the period of time before propagation is applied could be associated with the length of time for which railway vehicle brakes can be expected to remain active, and so keep the vehicle(s) stationary.

There are no requirements for the propagation of Unknown Track Status, for example following End of Mission, or following Loss of Train Integrity. The rationale for this is:

- 1) In places where vehicles are regularly parked, for example in sidings, there may be other measures to prevent rolling vehicles moving such that they are in conflict with other movements. For example, this might include the use of trap points, or derailleurs.
- 2) In places where vehicles are regularly stationary, for example in stations, there may be other measures to detect and mitigate the effect of rolling vehicles, for example by the use of Trackside Train Detection in station areas.

If these measures are used, there is no additional requirement to use propagation as a mitigation against collision.

If hazard analysis on a particular railway identifies that the remaining risk of unexpected vehicle movement causing a collision is still not acceptable, then the L3 Trackside system can include a propagation algorithm. However, it should be noted that:

- propagation may not provide full mitigation. A moving vehicle may not follow any propagation algorithm which is defined. For example, a moving vehicle might move before any timer defined in a propagation algorithm has elapsed, or might move further than any distance limit defined in a propagation algorithm.
- propagation may unduly impact railway operations.

### 3 System Requirements

This chapter provides System Requirements for an ETCS Level 3 system based on Baseline 3 Release 2 [BL3 R2] with Change Request 940 [CR940], where these requirements are in addition to the requirements for an ETCS Level 2 system.

The chapter is structured into different high-level topics relevant to the operation in ETCS Level 3. The following sub-sections contain an overview of the system functionality and the detailed system requirements.

The first sub-sections contain generic requirements listed in Table 8:

Sub-Section	Notes
3.1 Train location	Requirements for the processing of Train Position Reports to determine Train Location
3.2 Track Status	Requirements for the determination of Track Status Occupied / Clear / Unknown
3.3 Reserved Status	Requirements for Reserved status for areas where trains can be authorised to run
3.4 Fixed Virtual Blocks	Additional requirements for systems using Fixed Virtual Blocks
3.5 Trackside Train Detection	Additional requirements for systems using Trackside Train Detection

**Table 8 – Structure of Requirements**

Later sub-sections contain requirements relevant to specific operational situations or degraded modes.

Each requirement has been structured in four different parts:

- ID: each item is given a Unique ID, structured as follows:  
     <Type>-<Section>-<Number>  
     where:  
         <Type> is “REQ” for this part of D4.1  
         <Section> is an abbreviation within the document for a section of requirements  
         <Number> is a number unique to the document section  
     Requirements are labelled as Mandatory or Optional.
- Requirement: this is the text of the requirement to define the system behaviour
- Rationale: this is the reasoning explaining why and in which situations this requirement is needed
- Guidance: this is a proposal for the requirement implementation or other aspects to be considered during its implementation. The Guidance is not mandatory.

Where relevant, the Guidance is followed by references to Operational Rules (Part 4) and Engineering Rules (Part 5). Where the Guidance indicates that there may be a project-specific implementation, there are no references to Operational Rules or Engineering Rules, as these will also be project-specific.



Requirements which are in blue text like this paragraph are related to proposed changes to ETCS Baseline 3 Release 2 [BL3 R2] and CR940 [CR940]. They should be interpreted as suggestions for future improvements. They are tagged with 'Proposal'.

### 3.1 Train location

#### 3.1.1 Introduction

The L3 Trackside must be aware of all parts of the track that are potentially occupied by rail vehicles.

- For communicating trains, the L3 Trackside will create and update a Train Location for each train. The Train Locations are used to create or update Track Status Areas.
- For trains which are no longer communicating, there is no longer a Train Location. However, the Track Status Areas for these trains will be retained.

This section contains requirements relating to the determination of Train Location from Train Position Reports and Validated Train Data. Section 3.2 Track Status describes how Train Locations are used to determine Track Status Areas.

Within the L3 Trackside, the Train Location for a train is the L3 Trackside interpretation of the location of the train, based on Train Position Reports, Validated Train Data and other inputs if available, e.g. TTDs.

A Train Location has a front and a rear:

The front of the Train Location is the L3 Trackside view of the furthest position for the front of the train, based on Train Position Reports and other inputs, e.g. TTDs.

The rear of the Train Location is the L3 Trackside view of the furthest position for the rear of the train, based on Train Position Reports, Validated Train Data, TTDs, and other inputs, e.g. TTDs.

The different terms used within this section to determine a Train Location are summarised in Figure 15.

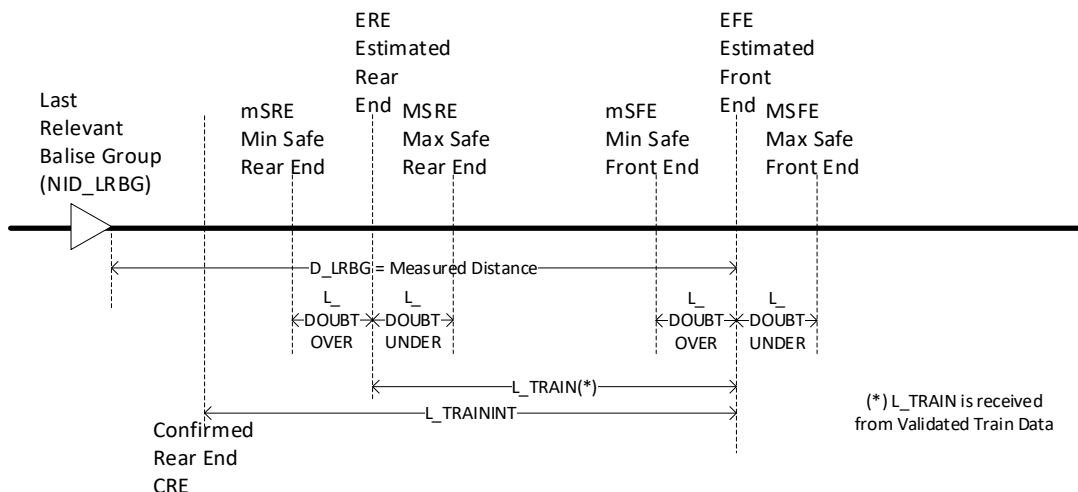


Figure 15: Terms used for Train Location

There are other sections which contain requirements for modification of a Train Location by other inputs, e.g. TTD.

The Requirements for Train Location are divided into subsections as follows:

- 3.1.2.1 General Train Location Requirements
- 3.1.2.2 Requirements to Create Train Location
- 3.1.2.3 Requirements to Update Train Location
- 3.1.2.4 Requirements to Remove Train Location
- 3.1.2.5 Reaction to Unexpected Train Locations

## 3.1.2 Requirements

### 3.1.2.1 General Train Location Requirements

REQ-TrainLoc-1	Mandatory	[X2R3 D4.2: REQ-TrainLoc-1]
----------------	-----------	-----------------------------

The L3 Trackside shall determine the Train Location for all communicating trains within or partly within its Area of Control.

#### Rationale:

It is critical that within a L3 System, where the primary means of locating trains is via Train Position Reports, the L3 Trackside maintains a record of the Train Locations of trains within its Area of Control. This is required for the L3 Trackside to be able to authorise train movements.

#### Guidance:

Communicating trains will provide their location through Train Position Reports, and their train length in Validated Train Data. The L3 Trackside will process Train Position Reports and Validated Train Data received from the leading cab of all communicating trains within its Area of Control.

The L3 Trackside will only use Train Position Reports from the leading cabs of trains to determine Train Location. Train Position Reports from NL or SL cabs will not be used.

Other systems may also provide additional information for Train Locations, for example TTD.

Operational Rules:     None  
Engineering Rules:     None

---



---

REQ-TrainLoc-2	Mandatory	[X2R3 D4.2: REQ-TrainLoc-11]
----------------	-----------	------------------------------

---

The L3 Trackside shall store the Train Location for all communicating trains within its Area of Control. The following information shall be stored:

1. Train ID (NID\_ENGINE)
2. Train Length (L\_TRAIN)
3. Most recent Train Position Report parameters
4. Most recent CRE
5. Time when the stored information was last valid
6. Train Running Number

Rationale:

This is to enable the L3 Trackside to recognise when the position has changed for a train which is already known to the L3 Trackside.

The stored information can also aid with initialising the L3 Trackside after a restart.

Guidance:

The time when the stored information was last valid is required in order to enable the possible use of the stored information during Trackside Initialisation.

Operational Rules:       None  
 Engineering Rules:       ENG-TrackInit-1

---



---

REQ-TrainLoc-3	Mandatory	[X2R3 D4.2: REQ-TrainLoc-2]
----------------	-----------	-----------------------------

---

The L3 Trackside shall report the Train Location and status for all trains within its Area of Control to the TMS.

Rationale:

This is to provide the Traffic Management System with information about the location of trains and their status so that Dispatchers can be aware of them.

Guidance:

In any exchange of information with the TMS, the L3 Trackside must include the Train ID and the Train Running Number so that the train can be identified.

The Dispatcher can use the reported information to decide upon subsequent action to take in normal and degraded operations.

The status of trains can consist of the following information (though information provided are application specific):

- Train Speed
- Mode
- Train Integrity status.

Operational Rules:       None  
 Engineering Rules:       None

**3.1.2.2 Requirements to Create Train Location**

REQ-TrainLoc-4	Mandatory	[New]
----------------	-----------	-------

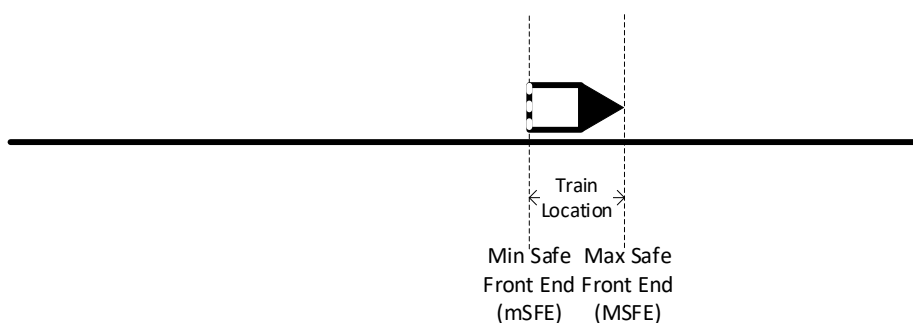
When receiving a Start of Mission Train Position Report from a train where the reported position is unambiguous to the L3 Trackside, the L3 Trackside shall create a new Train Location for that train from the Max Safe Front End to the Min Safe Front End derived from the Train Position Report.

**Rationale:**

For a train which has a new connection to the L3 Trackside, the L3 Trackside must create a new Train Location at the reported position.

**Guidance:**

At Start of Mission, before the receipt of Validated Train Data, only the Estimated Front End and its Confidence Interval are known to the L3 Trackside. The Train Location is then only from Max Safe Front End to Min Safe Front End, as shown in Figure 16.



**Figure 16: Train Location from Start of Mission Train Position Report**

In Figure 16 the Train Location is shown without train integrity confirmed. Train integrity cannot be confirmed until Validated Train Data has been acknowledged by the L3 Trackside.

How a Train Location which is partially outside the Area of Control is processed will be project specific.

There are requirements within section 3.9 Start of Mission covering the situations when the reported location is invalid or unknown, or is valid, but ambiguous to the L3 Trackside.

Operational Rules:     None  
 Engineering Rules:    None

---



---

REQ-TrainLoc-5	Mandatory	[New]
----------------	-----------	-------

---

When receiving a Train Position Report from a train for which there is no Train Location, the L3 Trackside shall create a Train Location for the train.

**Rationale:**

This is to enable the L3 Trackside to record the Train Location of all communicating trains in the Area of Control.

**Guidance:**

The L3 Trackside will need to create a new Train Location:

- For a train which has started a communication session within the Area of Control, but which is not performing Start of Mission
- For a train which has entered the Area of Control

For a train which has started a communication session within the Area of Control, but which is not performing Start of Mission, the new Train Location will be from Max Safe Front End to Min Safe Front End, as there will be no train integrity information provided.

For a train which has entered the Area of Control, and which has not confirmed Train Integrity, the new Train Location will be at least from the Max Safe Front End to the border of the Area of Control. This applies to both Handovers and Transitions.

How and when the first Train Location is established at the border to an Area of Control is project specific.

Operational Rules:       None

Engineering Rules:       None

### 3.1.2.3 Requirements to Update Train Location

---



---

REQ-TrainLoc-6	Mandatory	[X2R3 D4.2: REQ-SoM-10]
----------------	-----------	-------------------------

---

When receiving a new value of Train Length in Validated Train Data from a train, the L3 Trackside shall update the Train Location for this train using the new value of Train Length.

**Rationale:**

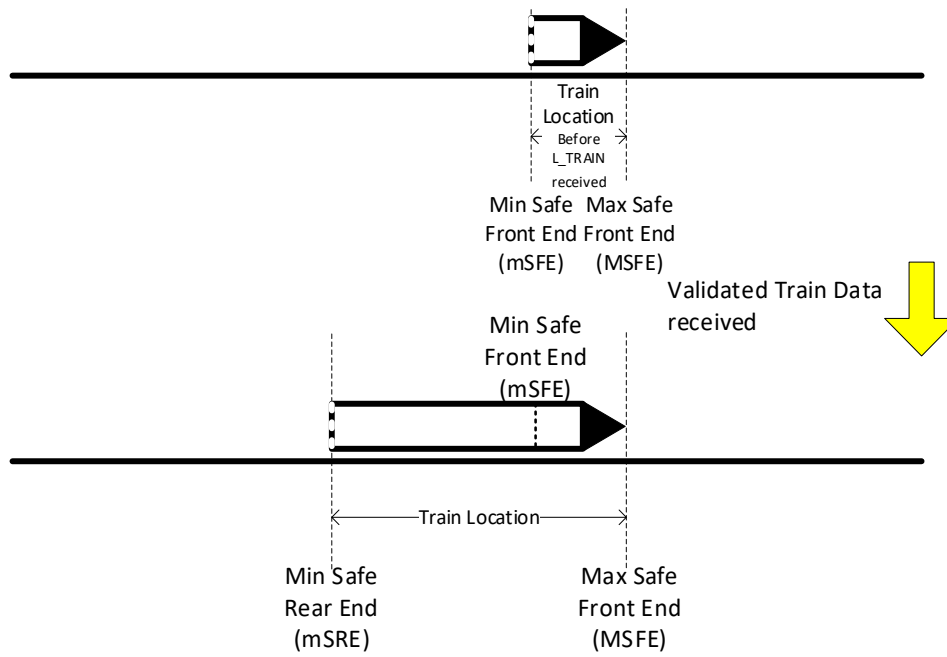
The receipt of a new value of Train Length in Validated Train Data represents new information from the train, which must be used to update the Train Location.

**Guidance:**

The only information used to determine Train Location from the Validated Train Data is the train length (L\_TRAIN).

A new value of L\_TRAIN means either the first value received since the Train Location was created, or a changed value received at some later time.

If this is the first value for L\_TRAIN received since the Train Location was created, then the Train Location is extended as shown in Figure 17.



**Figure 17: Train Location when receiving Validated Train Data during Start of Mission**

If this is a changed value of L\_TRAIN, then the new value of L\_TRAIN could be shorter than the previous value, for example after Splitting, as shown in Figure 18.

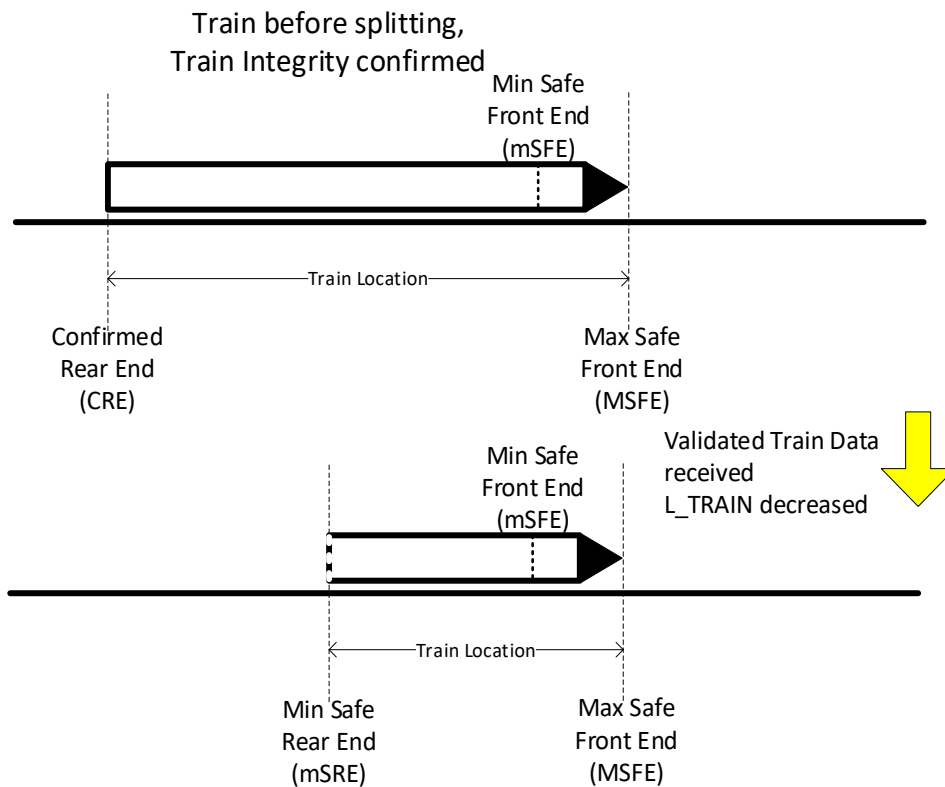
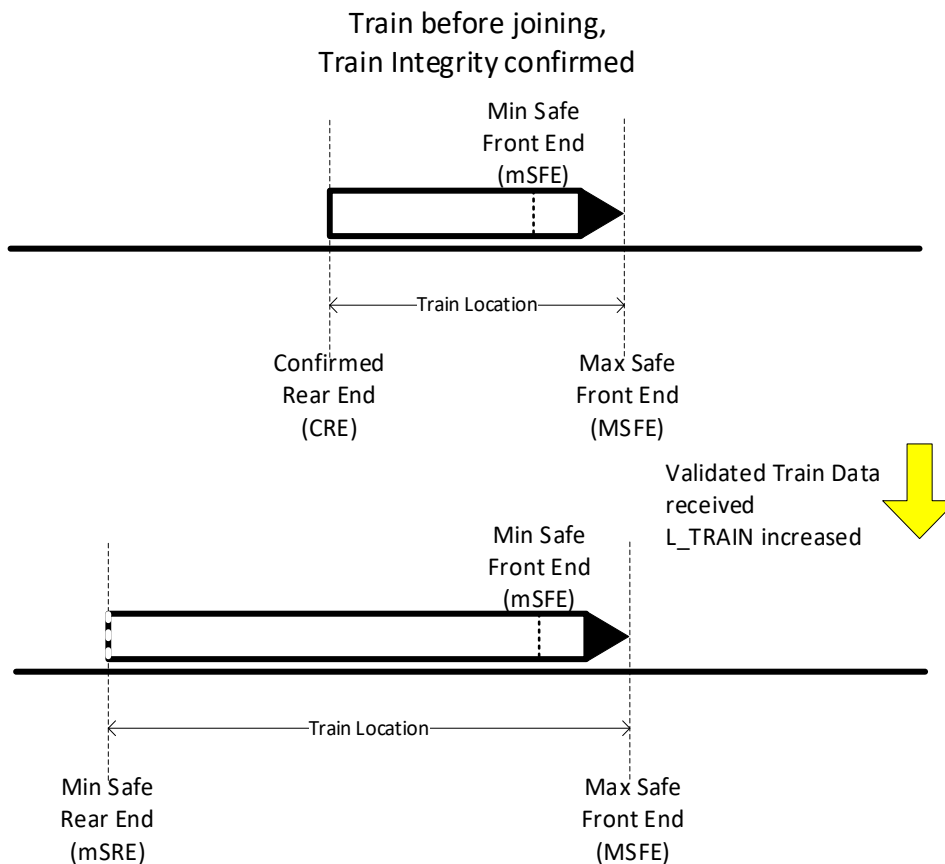


Figure 18: Train Location when receiving Validated Train Data, L\_TRAIN decreased

If this is a changed value of L\_TRAIN, then the new value of L\_TRAIN could be longer than the previous value, for example after Joining, as shown in Figure 19.



**Figure 19: Train Location when receiving Validated Train Data, L\_TRAIN increased**

If the new Train Location extends outside the Area of Control, how this is processed will be project specific.

Operational Rules: None  
 Engineering Rules: None

REQ-TrainLoc-7	Mandatory	[X2R3 D4.2: REQ-TrainLoc-4]
----------------	-----------	-----------------------------

When receiving a Train Position Report from a train where:

- The position is known to the L3 Trackside, AND
- There is a Train Location for that train

then the L3 Trackside shall update the front of the Train Location for this train using the Max Safe Front End derived from the Train Position Report.

Rationale:

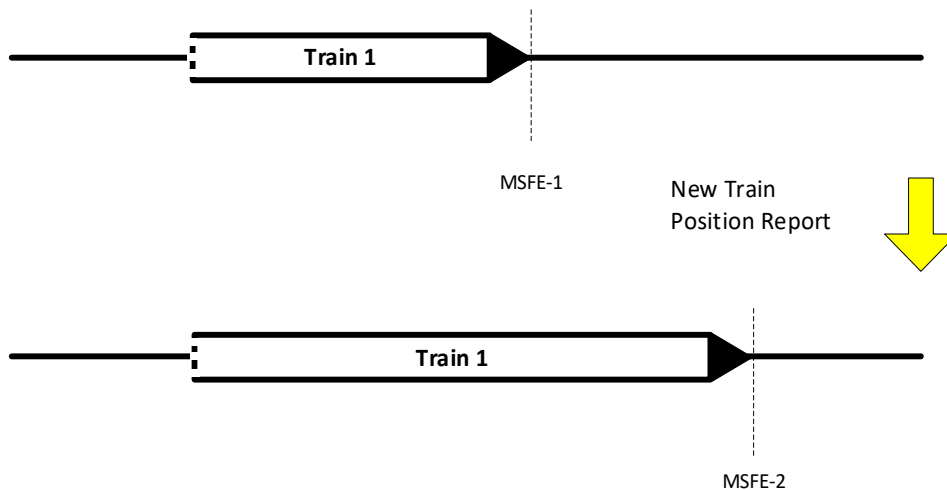
The L3 Trackside uses the information in Train Position Reports to update the Train Location of trains in its area.



Guidance:

The front of the Train Location for a train can be updated with every position report received, including trains in RV mode, if the position is known to the L3 Trackside.

Figure 20 shows how the front of the Train Location is updated with a new train position report.



**Figure 20: Front of Train Location updated from new Train Position Report**

Operational Rules: None  
 Engineering Rules: None

REQ-TrainLoc-8	Mandatory	[X2R3 D4.2: REQ-TrainLoc-5]
----------------	-----------	-----------------------------

When receiving a Train Position Report from a train where:

- The position is known to the L3 Trackside, AND
- There is a Train Location for that train, AND
- The train is in FS, OS or SB mode, AND
- Train Integrity is confirmed by external device

then the L3 Trackside shall update the rear of the Train Location for this train using the Confirmed Rear End derived from the Train Position Report.

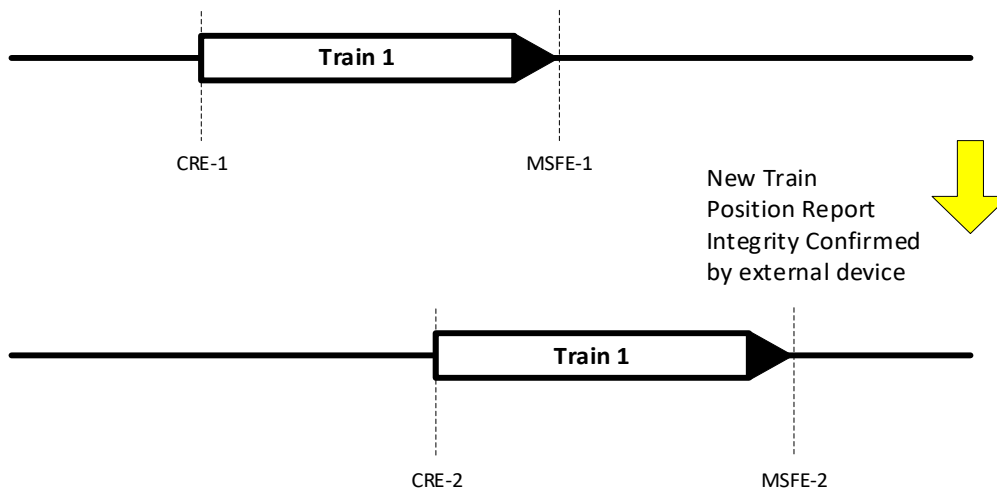
Rationale:

The L3 Trackside uses the information in Train Position Reports to maintain the Train Location of trains in its area.

Guidance:

The Confirmed Rear End is only known when receiving a Train Position Report with Train Integrity confirmed from which the L3 Trackside can locate the rear of the train in the track.

Figure 21 shows how the CRE is updated with a new train position report with Train Integrity Confirmed.



**Figure 21: Rear of Train Location updated from new Train Position Report, Integrity Confirmed**

Train Position Reports from trains in FS and OS mode will be from trains where linking is used. Train Position Reports from trains in SB allow for defining a Train Location at Start of Mission. Other modes, including SR, are excluded as there are issues with relocation.

Operational Rules: None  
 Engineering Rules: None

REQ-TrainLoc-9	Optional	[X2R3 D4.2: REQ-TrainLoc-6]
----------------	----------	-----------------------------

When receiving a Train Position Report from a train where:

- The position is known to the L3 Trackside, AND
- There is a Train Location for that train, AND
- The train is in FS, OS or SB mode, AND
- Train Integrity is confirmed by Driver, AND
- The L3 Trackside is configured to accept Train Integrity confirmed by Driver

then the L3 Trackside shall update the rear of the Train Location for this train using the Confirmed Rear End derived from the Train Position Report.

Rationale:

The L3 Trackside uses the information in Train Position Reports to update the Train Location of trains in its area.

Guidance:

The Confirmed Rear End is only known when receiving a Train Position Report with Train Integrity confirmed from which the L3 Trackside can locate the rear of the train in the track.

If Train Integrity is confirmed by the driver, then the Train Location is only updated if the L3 Trackside is configured to accept this.

Train Position Reports from trains in FS and OS mode will be from trains where linking is used. Train Position Reports from trains in SB allow for defining a Train Location at Start of Mission. Other modes, including SR, are excluded as there are issues with relocation.

Operational Rules: OPE-Generic-3  
 Engineering Rules: ENG-LossTI-2

**3.1.2.4 Requirements to Remove Train Location**

REQ-TrainLoc-10	Mandatory	[New]
-----------------	-----------	-------

The L3 Trackside shall remove the Train Location for a train when the L3 Trackside considers that the train is no longer in communication with the L3 Trackside.

Rationale:

The L3 Trackside cannot determine the Train Location for a train when the communication session has been terminated or is considered terminated.

Guidance:

A train is no longer in communication with the L3 Trackside if:

- The communication session has been terminated, or
- The communication session timer has expired, or
- A Radio Hole timer for a train has expired.

If the train was within or partially within the Area of Control when the communication session was closed, then even though the Train Location is removed, the Track Status Area for the train will remain.

Operational Rules: None  
 Engineering Rules: None

REQ-TrainLoc-11	Mandatory	[New]
-----------------	-----------	-------

The L3 Trackside shall remove the Train Location for a train which has completely left the Area of Control.

Rationale:

The L3 Trackside does not need to maintain a Train Location beyond its Area of Control.

Guidance:

This applies to both Handovers and Transitions.

How the removal is achieved is project specific. Options include:

- Monitoring the Train Location for a train which is leaving the Area of Control, until it is completely beyond the boundary of the Area of Control.
- Truncating the Train Location at the boundary for a train which is leaving the Area of Control, until it has zero length within the Area of Control

It is also possible to use short TTD sections at boundaries of the Area of Control to determine when a train has left the area.

Projects may decide to maintain the Train Location beyond the border until ordering the train to terminate the communication session.

Projects may decide to implement different solutions at different borders of the Area of Control.

Operational Rules: None

Engineering Rules: None

### 3.1.2.5 Reaction to Unexpected Train Locations

REQ-TrainLoc-12	Mandatory	[X2R3 D4.2: REQ-StartTrain-8]
-----------------	-----------	-------------------------------

If a train reports a position that is unexpected or in conflict with other train movements, the L3 Trackside shall react to transition the system to a safe state.

Rationale:

The L3 Trackside should react if it detects a hazardous situation.

Guidance:

A similar situation could occur in a L2 railway. However, the situation is more severe in a L3 area, where TTD may not be present, and the L3 Trackside is reliant upon trains reporting their position to separate traffic safely.

The L3 Trackside will only be able to detect conflict with other train movements which have been authorised by the L3 Trackside.

There are several situations where a position report from a train may require immediate action from the L3 Trackside in order to avoid a potential hazard:

- A train reporting a position in an area previously considered clear, e.g. at Start of Mission
- A train which has been allocated a Reserved Status Area reporting a position which cannot be linked with the Reserved Status Area
- A train reporting a position locating it within a Reserved Status Area allocated to another train.

The specific reaction applied will depend on the situation and application specific requirements. Possible reactions include:

- shortening of the Movement Authority for the affected train(s),
- sending an Unconditional Emergency Stop message to the affected train(s).

Note that the Train Location is created or updated by other requirements.

Operational Rules: None

Engineering Rules: None

---

REQ-TrainLoc-13	Mandatory	[X2R3 D4.2: REQ-TrainLoc-9]
-----------------	-----------	-----------------------------

---

If a train reports a position that is unexpected or in conflict with other train movements, the L3 Trackside shall alert the TMS to the situation.

Rationale:

This is to make the TMS aware in case the reported position could be a real or potential hazard for other train movements.

Guidance:

A similar situation could occur in a L2 railway. However, the situation is more severe in a L3 area, where TTD may not be present, and the L3 Trackside is reliant upon trains reporting their position to separate traffic safely.

The L3 Trackside will only be able to detect conflict with other train movements which have been authorised by the L3 Trackside.

There are several situations where a position report from a train may require additional intervention from the TMS in order to manage the degraded situation. For example:

- A train reporting a position in an area previously considered clear, e.g. at Start of Mission
- A train reporting a position locating it within a Reserved Status Area allocated to another train.

Operational Rules: None

Engineering Rules: None

## 3.2 Track Status

### 3.2.1 Introduction

The L3 Trackside determines the status of the track within its Area of Control, i.e. whether each part of the track is Occupied, Unknown or Clear. For an introduction to Track Status, see section 2.2 above.

Every Train Location will have a Track Status Area, which may be Occupied or Unknown. A train and its Train Location can only be associated with one Track Status Area. An Occupied Track Status area can only have one train associated with it, while an Unknown Track Status Area can have more than one train associated with it, e.g. after splitting if two trains perform Start of Mission at the same time within the Track Status Area resulting from EoM.

In addition, there will be other Track Status Areas without any train associated with it, for example as a result of trains which have ceased communications with the L3 Trackside, or Track Status Areas created by the TMS. These Track Status Areas will be Unknown.

The Requirements for Track Status are divided into subsections as follows:

- 3.2.2.1 Consolidated Track Status
- 3.2.2.2 Impact from creating a Train Location
- 3.2.2.3 Updating a Track Status Area
- 3.2.2.4 Removing a Track Status Area
- 3.2.2.5 TMS Related Track Status Requirements
- 3.2.2.6 Other Track Status Requirements

Other sections within this document also have an impact on Track Status Areas.

## 3.2.2 Requirements

### 3.2.2.1 Consolidated Track Status

REQ-TrackStatus-1	Mandatory	[X2R3 D4.2: REQ-TrackStatus-1]
-------------------	-----------	--------------------------------

The L3 Trackside shall determine the Consolidated Track Status of the entire track within the Area of Control.

Rationale:

It is critical that within a system where the means of locating trains is via Train Position Reports, the Trackside maintains an up to date record of the Track Status within its Area of Control.

Guidance:

An area of track within the Area of Control will be Occupied, Unknown or Clear. The L3 Trackside determines this Consolidated Track Status for the complete Area of Control from all the individual Track Status Areas.

In the absence of any Track Status Area the Track Status of that part of the railway is Clear

Operational Rules: None  
Engineering Rules: None

---



---

REQ-TrackStatus-2	Mandatory	[X2R3 D4.2: REQ-TrackStatus-2]
-------------------	-----------	--------------------------------

---



---

When Track Status Areas overlap, the Consolidated Track Status shall give precedence to Occupied over Unknown.

**Rationale:**

Occupied is considered to have precedence over Unknown, as it is more restrictive.

**Guidance:**

Overlap of Occupied and Unknown Track Status Areas may occur when a train enters an Active Shunting Area, when sweeping is performed by a train with confirmed Train Integrity, or during splitting and joining movements.

Operational Rules:     None

Engineering Rules:     None

### 3.2.2.2 Impact from creating a Train Location

---



---

REQ-TrackStatus-3	Mandatory	[X2R3 D4.2: REQ-SoM-6]
-------------------	-----------	------------------------

---



---

When at Start of Mission a Train Location has been created for a train with the min Safe Front End located within a Sweepable Unknown Track Status Area, then the train shall be associated with this Track Status Area.

**Rationale:**

This is to have each communicating train associated with a Track Status Area.

**Guidance:**

All communicating trains with a position known by the L3 Trackside must be associated with a Track Status Area to be protected and to protect other trains.

In case there were several Sweepable Unknown Track Status Areas overlapped, it is project specific to decide to which one of them the train is associated with, e.g. depending on the reason to create the Unknown Track Status Area or to check the NID\_ENGINE stored in the Area.

In case the Train Location is located within a Sweepable Unknown Track Status Area which was created at Trackside Initialisation, then it is project specific whether to associate the Train Location with the existing Unknown Track Status Area, or create a new Unknown Track Status Area.

A train cannot be associated with a Non-Sweepable area because such areas are meant to remain at a defined location, while trains are meant to move.

Operational Rules:     None

Engineering Rules:     None

REQ-TrackStatus-4	Mandatory	[X2R3 D4.2: REQ-SoM-9]
-------------------	-----------	------------------------

When at Start of Mission a Train Location has been associated with a Track Status Area and a part of the Train Location is outside this area, then the Track Status Area shall be extended to cover that Train Location.

Rationale:

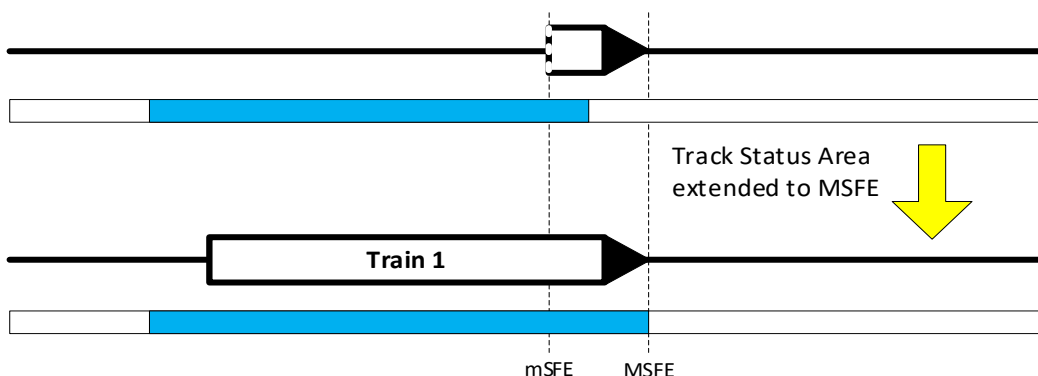
This is to have each Train Location within its associated Track Status Area.

Guidance:

All communicating trains with a position known by the L3 Trackside must be associated with a Track Status Area covering the full extent of its Train Location to be protected and to protect other trains.

A train performing Start of Mission may report with its Max Safe Front End being somewhat beyond the Unknown Track Status Area it has been associated with, e.g. if opening a desk in the other end of the train or if it had to move a bit to split. In this case the associated Track Status Area must be extended to protect the train, as seen in Figure 22 below.

In Figure 22 below, the Train Location is initially not aligned with the Track Status Area it has been associated with. Therefore, the area is extended to cover the Max Safe Front End while the rear of the area is kept where it is.



**Figure 22: Unknown Track Status Area adjusted for the created Train Location**

This requirement also applies when a Train Location is extended after receiving Validated Train Data, i.e. adjusting it according to the reported Train Length.

Operational Rules: None  
 Engineering Rules: None

REQ-TrackStatus-5	Mandatory	[X2R3 D4.2: REQ-SoM-8]
-------------------	-----------	------------------------

When at Start of Mission a Train Location has been created for a train where the min Safe Front End is not located within a Sweepable Unknown Track Status Area, then a new Unknown Track Status Area shall be created for the extent of this Train Location and the train shall be associated with that area.



**Rationale:**

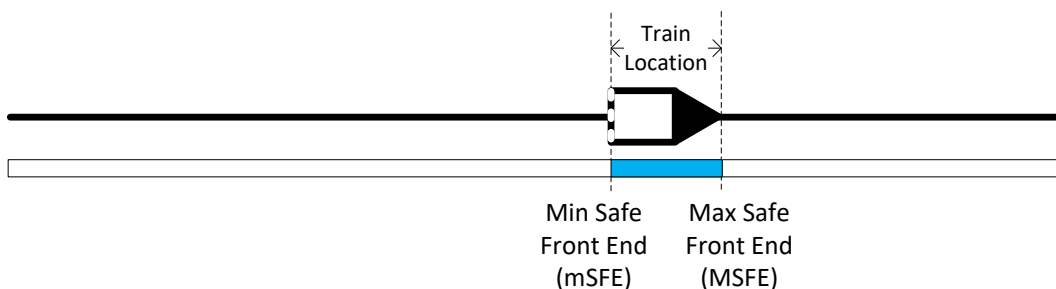
This is to have each communicating train associated with a Track Status Area.

**Guidance:**

All communicating trains with a position known by the L3 Trackside must be associated with a Track Status Area to be protected and to protect other trains.

When a Train Location cannot be associated with an already existing Sweepable Unknown Track Status Area, then it is necessary to create a new Track Status Area for that Train Location. This can happen in a clear area of track, in an Occupied Track Status Area, or in a Non-Sweepable Unknown Track Status Area.

Figure 23 below illustrates the creation of a new Unknown Track Status Area when a Train Location has been created in a previously clear area of track.



**Figure 23: Unknown Track Status Area created from Train Location at Start of Mission**

Operational Rules: None  
 Engineering Rules: None

REQ-TrackStatus-6	Mandatory	[New]
-------------------	-----------	-------

When a Train Location is created for a train entering the L3 Area of Control, then the L3 Trackside shall create a new Unknown Track Status Area for the extent of this Train Location and the train shall be associated with that area.

**Rationale:**

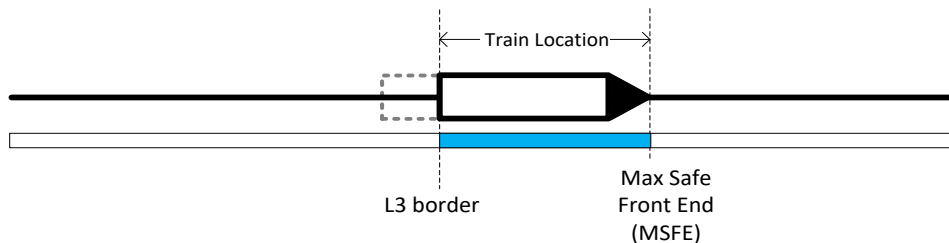
This is to have each communicating train associated with a Track Status Area.

**Guidance:**

All communicating trains with a position known by the L3 Trackside must be associated with a Track Status Area to be protected and to protect other trains.

The status of the new Track Status Area depends on the train that created the Train Location, e.g. the status will be Occupied when a train with confirmed Train Integrity enters the L3 Area of Control.

Figure 24 below illustrates the creation of a new Unknown Track Status Area when a Train Location has been created for a train entering the L3 Area for which the rear end has not passed the L3 border. The status of the area will be changed to Occupied by another requirement if the train also confirmed integrity.



**Figure 24: Track Status Area created from Train Location when train enters L3 Area**

The dashed ‘box’ in the figure above shows the real extent of the train and projects may decide to extend the Train Location, and the Track Status Area associated with the train, beyond the border.

Operational Rules: None  
 Engineering Rules: None

**3.2.2.3 Updating a Track Status Area**

REQ-TrackStatus-7	Mandatory	[New]
-------------------	-----------	-------

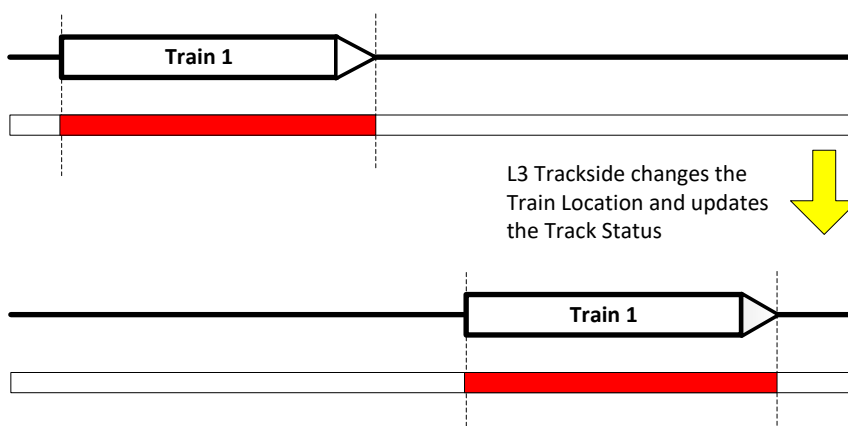
When the L3 Trackside has updated the Train Location for a train, then the Track Status Area associated with this train shall be updated accordingly.

Rationale:

This is for the L3 Trackside to maintain the Track Status within its Area of Control.

Guidance:

The L3 trackside updates the start and end location of a Track Status Area according to the Train Location of the associated train, when the front and/or rear of this train has been updated by train position reports, changes to the train length in the Validated Train Data or by information from TTDs.



**Figure 25: Track Status Area updated from Train Location**

In Figure 25 above, the front of the train is ‘hollow’ instead of filled as the location of the train may have been adjusted by TTD (see Section 3.5.2).

Operational Rules: None  
 Engineering Rules: None

---



---

REQ-TrackStatus-8	Mandatory	[X2R3 D4.2: REQ-StartTrain-11]
-------------------	-----------	--------------------------------

---



---

The L3 Trackside shall alert the TMS to the situation if:

- the L3 Trackside has updated the Train Location for a train, AND
- the new reported train length is now greater than the Recorded Train Length for the Track Status Area associated with this train, AND
- there are no adjacent Unknown Track Status Area(s) where the Recorded Train Length can account for the increased train length

Rationale:

If a train has reported new Validated Train Data where the train length has increased, and the increase in length cannot be accounted for by the Recorded Train Length in some adjacent Track Status Area(s), then there may have been an error when updating the length of this or another train, which should be brought to the attention of the TMS.

Guidance:

The increase in the train length for the Train Location will be because the L3 Trackside has received Validated Train Data with an increased value of L\_TRAIN.

A train is expected to send Validated Train Data with an increased value of L\_TRAIN if it has performed a joining operation. In this case, there should be one or more adjacent Unknown Track Status Areas, where the additional Recorded Train Length(s) can account for the increased train length.

If there are no adjacent Unknown Track Status Areas which can account for the increased train length, then some error has occurred, and the TMS will be alerted.

An inconsistency in the reported length from a train and the length stored by the L3 Trackside could be due to an error in the stored data, or failure in the application of Operational Rules. The L3 Trackside may decide to take a protective reaction, such as extending an Unknown Track Status Area to cover the train location. This reaction is project specific.

Operational Rules: None

Engineering Rules: None

---



---

REQ-TrackStatus-9	Mandatory	[X2R3 D4.2: REQ-TrackStatus-3]
-------------------	-----------	--------------------------------

---



---

When Train Integrity is confirmed by External Device for a train associated with an Unknown Track Status Area and the length of this train (L\_TRAIN) is equal to or longer than the Recorded Train Length for that area, then the L3 Trackside shall change the status for that area to Occupied.

Rationale:

This is required for the L3 Trackside to maintain the Track Status within its Area of Control.

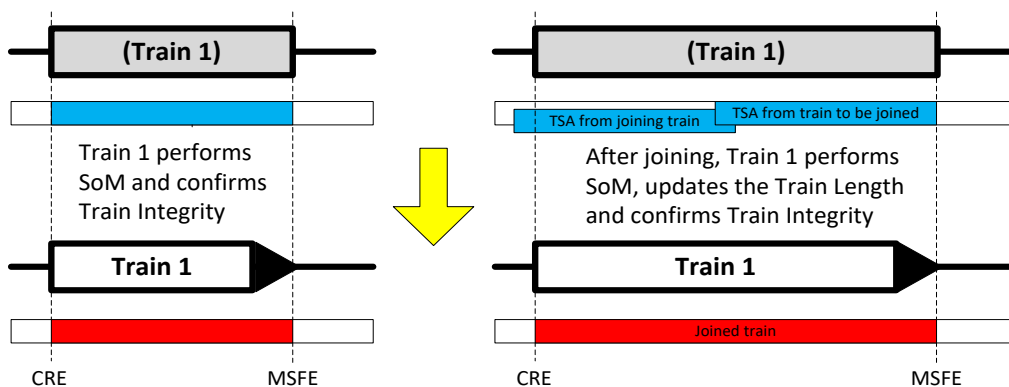
Guidance:

Unless the position of a train is not known to the L3 Trackside, it will always have created an Unknown Track Status Area for a train before it confirms integrity. If the Train Location is created later, e.g. after a Dispatcher has assigned a position to the train, there will still be an Unknown Track Status Area which is changed to Occupied when integrity is confirmed.

The length of the train could be longer than what is recorded for the Unknown Track Status Area in case two trains were joined after performing EoM and the joined train is associated with one of two unknown Track Status Areas.

Projects may decide to allow for some tolerance in matching the length of a train with what is recorded for the Track Status Area. In that case, the tolerance can be the configurable minimum length of Unknown Track Status Areas, as defined in ENG-Generic-3. Projects may also decide to check if there is another Unknown Track Status Area nearby that could explain the new longer Train Length and to alert the TMS if this is not the case.

Figure 26 shows the relationship between Train Location and the Occupied Track Status Area for an individual train with Train Integrity, one where the length of the train is the same as that recorded for the Unknown Track Status Area and one where the length is longer.



**Figure 26: Occupied Track Status Area after confirmation of Train Integrity**

In the righthand example, there is a step missing when the Train Location and the associated Track Status Area is updated with the Train Length after receiving Validated Train Data, because this requirement is only about changing the status of the Track Status Area. However, when updating the area with the Train Length, projects could decide to merge it with the adjacent area if the sum of the lengths recorded for these areas matches the one reported by the train. Projects may also decide not to merge the areas and instead have the rear area swept when the train confirms integrity. In the end, when the total length matches, the result should be the same with only an Occupied Track Status Area and no Unknown.

Operational Rules: None

Engineering Rules: ENG-Generic-3

---



---

REQ-TrackStatus-10	Mandatory	[New]
--------------------	-----------	-------

---



---

When Train Integrity is confirmed by External Device for a train associated with an Unknown Track Status Area and the length of this train is less than the Recorded Train Length for that area, then the L3 Trackside shall:

- create a new Occupied Track Status Area for this train's Train Location, AND
- associate the train with that Occupied area instead of the Unknown area, AND
- remove the part of the Unknown Track Status Area between the min Safe Front End to the Max Safe Rear End of the train, AND
- reduce the Recorded Train Length of the remaining Unknown Track Status Area(s) by the length of the train that confirmed Train Integrity

Rationale:

This is required for the L3 Trackside to maintain the Track Status within its Area of Control when all the train length recorded for an Unknown Track Status Area is not accounted for by a train confirming integrity.

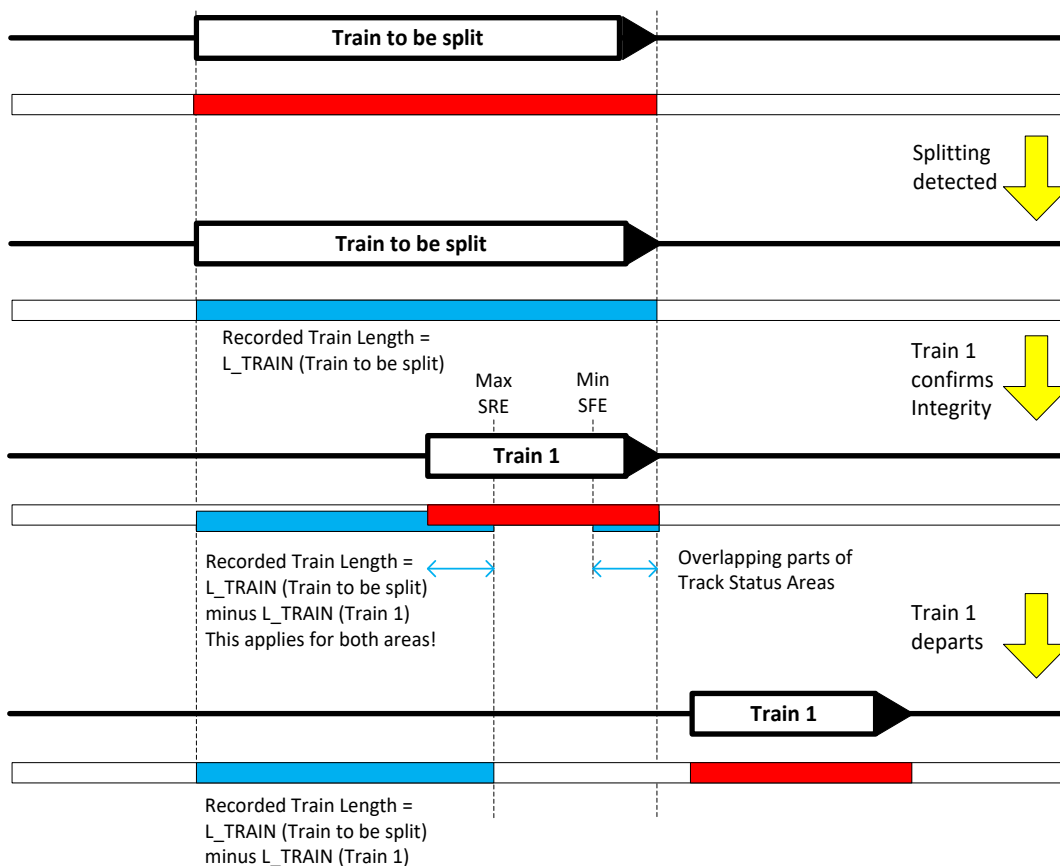
Guidance:

An Unknown Track Status Area cannot be fully recovered if the reported train length does not account for all the train length recorded for that area. In this case, the Unknown Track Status Area must remain with the recorded train length reduced by the length of the train that confirmed integrity.

The extent of the Unknown Track Status Area will also be reduced because the new overlaying Occupied area will sweep the part of the Unknown area from its Min Safe Front End to the Max Safe Rear End. This could result in this area being split in two, depending on the location of the Occupied Track Status Area. In that case the recorded train length is the same for both Unknown areas.

The train that confirmed integrity will be associated with a new (Occupied) Track Status Area based on its Train Location. When a train is associated with a new Track Status Area, it is no longer associated with any other Track Status Area.

Figure 27 shows an example of a train accounting for part of the length recorded for an Unknown Track Status Area after splitting and that area being split by the train when it confirms integrity. Here, the Front Train After Splitting, train 1 in the figure, confirms integrity and leaves before the rear part has performed SoM. As the train moves away, it sweeps the part of the Unknown Track Status area at the front of the train, while the overlapped part at the rear becomes visible.



**Figure 27: Unknown Track Status Area remains when Front Train after Splitting leaves**

The process above is repeated if another train performs Start of Mission in the remaining Unknown Track Status Area. After splitting, any end could perform Start of Mission first, but the handling is the same.

Projects may decide to allow for some tolerance in matching the length of a train with what is recorded for the Track Status Area. In that case, the tolerance can be the configurable minimum length of Unknown Track Status Areas, as defined in ENG-Generic-3.

Operational Rules: None  
 Engineering Rules: ENG-Generic-3

REQ-TrackStatus-11	Mandatory	[New]
--------------------	-----------	-------

When an Unknown Track Status Area is split and this has a Recorded Train Length, then the L3 Trackside shall store this length for all Unknown Track Status Areas resulting from this split.

Rationale:

This is to avoid that some train and/or waggons are lost to the L3 Trackside when an Unknown Track Status Area is split.

**Guidance:**

Unknown Track Status Areas can be split by a TTD section detected clear or by a train which confirms integrity and thereby creates an overlapping Occupied Track Status Area. In some situations, e.g. over a set of points, an Unknown area could even be split in more than two parts.

Even if the extents of the split areas are very different, the L3 Trackside cannot safely judge if one of them should have more of the recorded length than the other and what that length should be. This is the same situation as if an Unknown Track Status Area is split by a clear TTD section.

In case the split areas are the result of a train confirming integrity after splitting, then one of the areas could be very short and easily swept when that train is authorised to move (with a short mode profile in OS). Thus, it is obvious that the remaining Unknown Track Status Area must cover for all the length that was left after the train departed, else some of the recorded length would be lost to the L3 Trackside after the other area was swept. This is illustrated in Figure 27 for the requirement above.

Operational Rules: None

Engineering Rules: None

---



---

REQ-TrackStatus-12	Optional	[New]
--------------------	----------	-------

---

When Train Integrity is confirmed by Driver for a train associated with an Unknown Track Status Area and the length of this train is less than the Recorded Train Length of the Unknown Track Status Area, then the L3 Trackside shall:

- create a new Unknown Track Status Area for this train's Train Location, AND
- associate the train with that area, AND
- reduce the Recorded Train Length of the remaining Unknown Track Status Area(s) by the length of the train that confirmed Train Integrity

**Rationale:**

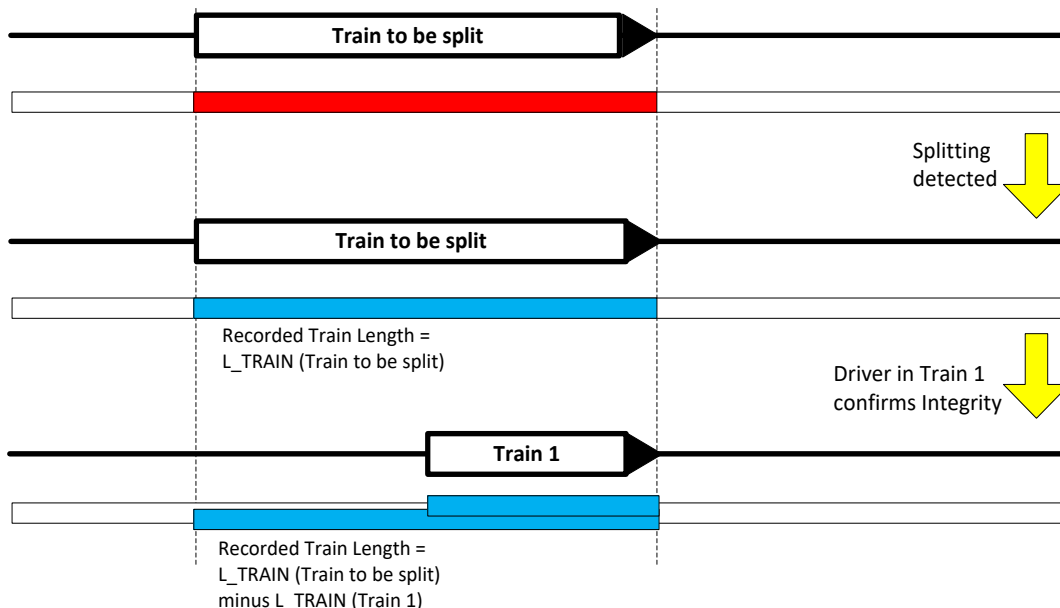
An Unknown Track Status Area cannot be fully removed if a reported train length does not account for all the Recorded Train Length of that area.

**Guidance:**

When a train is associated with a new Track Status Area, it will no longer be associated with any other Track Status Area.

Figure 28 shows an example of a train accounting for part of the length recorded for an Unknown Track Status Area after splitting when its Driver has confirmed integrity. The new Unknown Track Status Area associated with Train 1 overlaps

the existing area, for which the Recorded Train Length is reduced by the length of Train 1.



**Figure 28: Unknown Track Status Area created after integrity confirmed by Driver**

Operational Rules: None  
 Engineering Rules: None

REQ-TrackStatus-13	Mandatory	[New]
--------------------	-----------	-------

When Train Integrity is confirmed for a train associated with an Unknown Track Status Area located within an Activated Temporary Shunting Area, then the L3 Trackside shall reduce the Recorded Train Length of the Unknown Track Status Area associated with the Shunting Area by the length of the train that confirmed Train Integrity.

**Rationale:**

This is required for the L3 Trackside to maintain the Track Status within its Area of Control.

**Guidance:**

If all the train length recorded for an Active Shunting Area is accounted for when the area is deactivated, then the Unknown Track Status Area that was associated with the Shunting Area can be removed, else it will remain but be Sweepable.

Operational Rules: None  
 Engineering Rules: None



REQ-TrackStatus-14	Mandatory	[X2R3 D4.2: REQ-TrackStatus-5]
--------------------	-----------	--------------------------------

When a Track Status Area associated with a train is updated based on a new Train Location and the front of the train has passed a part or all of a Sweepable Unknown Track Status Area that existed before the Train Location was updated, then the L3 Trackside shall reduce that Unknown Track Status Area for the part of it from the previous Min Safe Front End up to the new Min Safe Front End of the train.

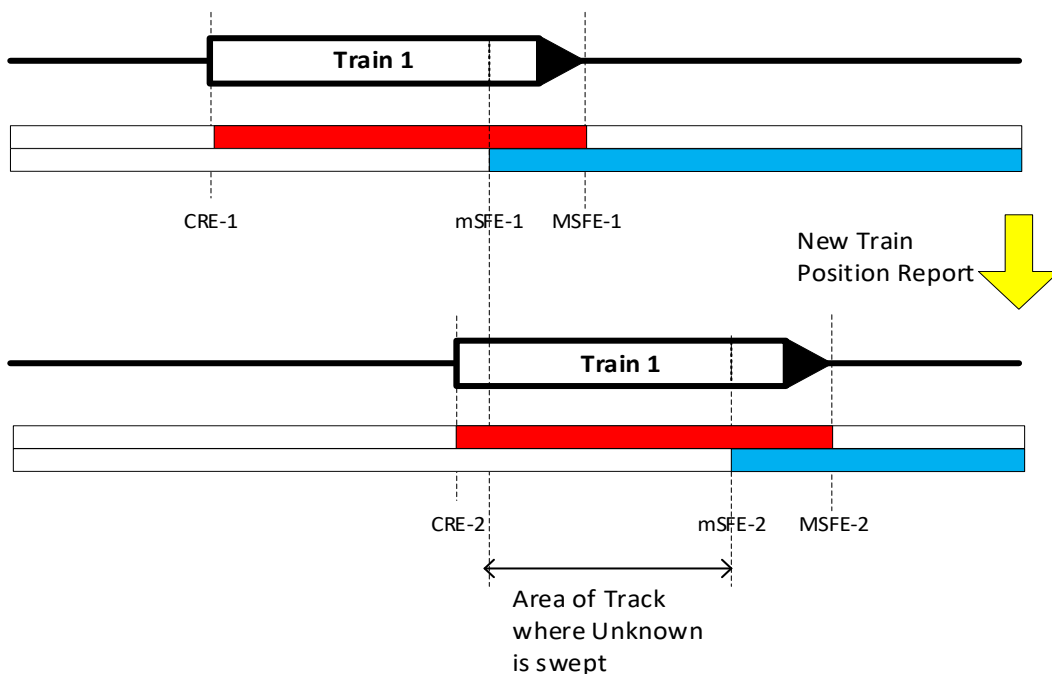
**Rationale:**

This is to enable sweeping of the area passed between received position reports.

**Guidance:**

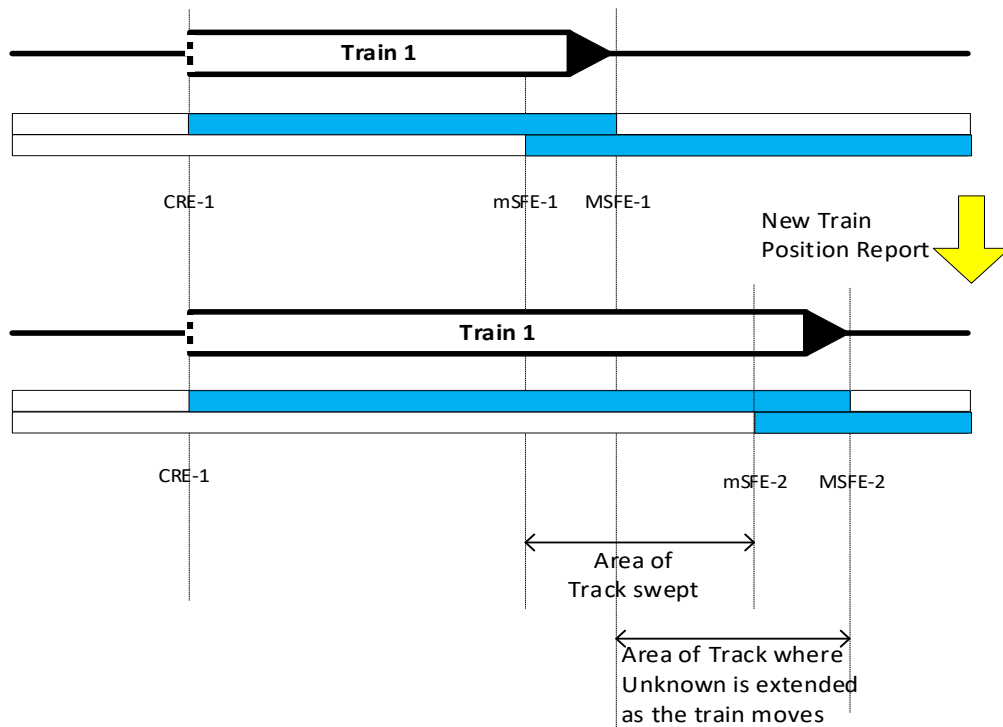
Sweeping is performed by the Min Safe Front End (mSFE) of a train, as it cannot be guaranteed that there is no obstruction between the mSFE and the Max Safe Front End (MSFE) which is the Confidence Interval where the front of the train can be.

Figure 29 shows the relationship between Train Location and the Occupied Track Status Area for a train with Train Integrity confirmed in a Sweepable Unknown Track Status Area ahead of the train.



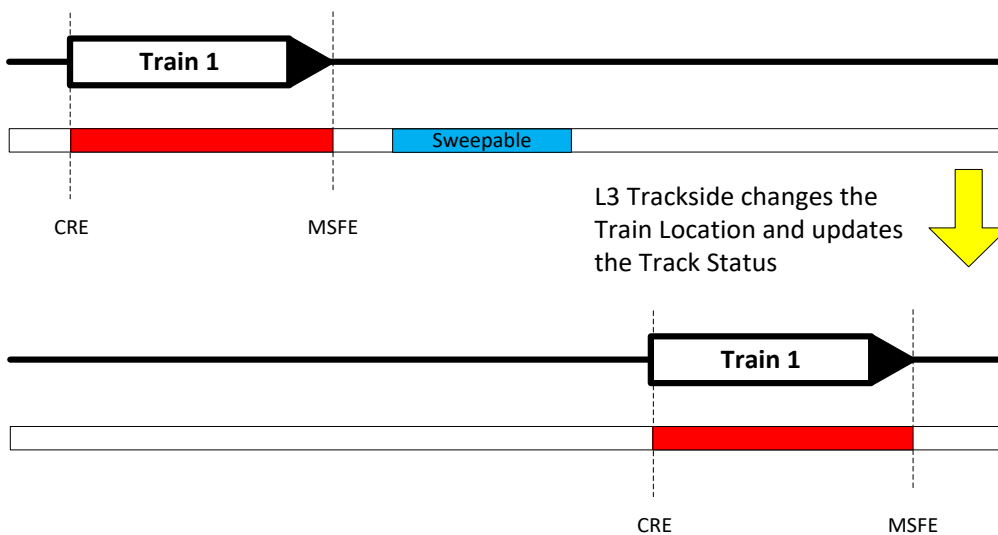
**Figure 29: Train with Train Integrity confirmed Sweeping an Unknown Track Status Area**

Figure 30 shows the relationship between Train Location and the Unknown Track Status Area for a train without Train Integrity confirmed in a Sweepable Unknown Track Status Area ahead of the train. The train is sweeping the area in front of the train and extending the one created as train is reporting without Train Integrity Confirmed.



**Figure 30: Train without Train Integrity Confirmed Sweeping an Unknown Track Status Area**

Figure 31 below shows a train having passed a Sweepable Unknown Track Status Area between a new and the previous Train Location. The train sweeps that Unknown Track Status Area.



**Figure 31: Existing Unknown Track Status Area swept by a passing train**

The passage of a train through a Sweepable Unknown Track Status Area sweeps that Unknown Track Status Area.

Sweeping will not be applied when a train reports in RV mode. A reversing train will not sweep its own Unknown Track Status Area. However, the Max Safe Front end is updated as the train reports while reversing.

Operational Rules: None  
 Engineering Rules: None

When a Track Status Area associated with a train is updated based on a new Train Location and this train has passed a part or all of a Sweepable Unknown Track Status Area that did not exist before the Train Location was updated, then the L3 Trackside shall reduce that Unknown Track Status Area for the part of it between the Min Safe Front End and the Max Safe Rear End of the train.

Rationale:

This is to enable (partial) sweeping of an Unknown Track Status Area that was created between received position reports.

Guidance:

Sweeping is performed by the Min Safe Front End (mSFE) of a train, as it cannot be guaranteed that there is no obstruction between the mSFE and the Max Safe Front End (MSFE) which is the Confidence Interval where the front of the train can be.

A hazardous situation may arise if an Unknown Track Status Area is swept by a train if this Unknown area was created only after the train had passed it.

Figure 32 below shows a train having passed a Sweepable Unknown Track Status Area between a new and the previous Train Location. As the area did not exist before the Train Location was updated, it only sweeps that Unknown Track Status Area the new Min Safe Front End and the new Max Safe Rear End of the train.

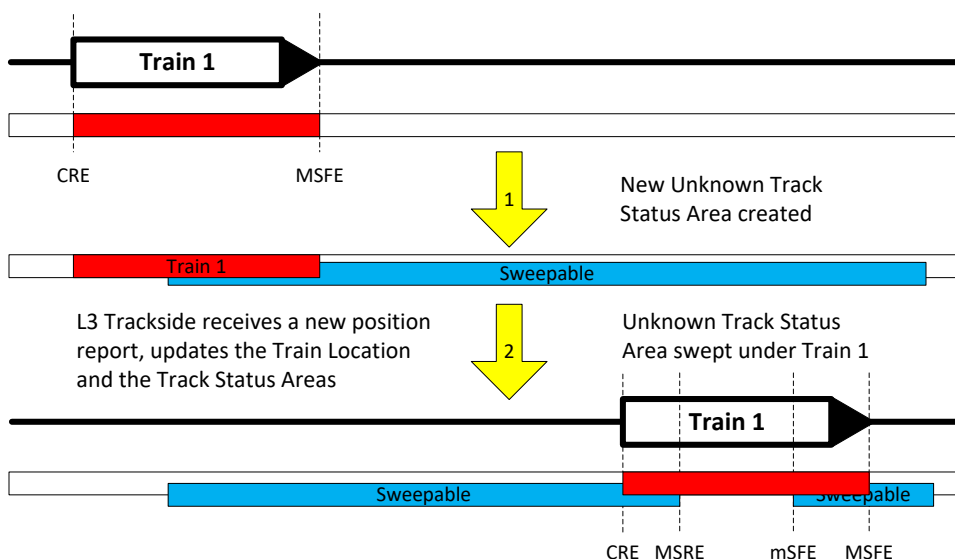


Figure 32: New Unknown Track Status Area swept by a passing train

Operational Rules: None

Engineering Rules: None

---



---

REQ-TrackStatus-16	Mandatory	[X2R3 D4.2: REQ-TrackStatus-18]
--------------------	-----------	---------------------------------

---



---

When the L3 Trackside considers the communication session with a train is terminated, the L3 Trackside shall change an Occupied Track Status Area associated with this train to Unknown, except if the train is completely located inside an Active Shunting Area.

**Rationale:**

This is the area where the train could be located, and as such needs to be protected by an Unknown Track Status Area.

**Guidance:**

This requirement applies at EoM for trains not inside an Active Shunting Area.

For a train located completely inside an Active Shunting Area, there is no need for an Unknown Track Status Area since there is already an Unknown area associated with the Active Shunting Area which will protect the train.

If a train is partially located inside an Active Shunting Area, it is project specific whether the L3 Trackside authorises the transition to Shunting Mode. Similarly, it is project specific how the L3 Trackside subsequently manages the overlapping Unknown Track Status Area that is created for the location of this train.

For a train leaving the L3 Area, another requirement deals with the relevant Track Status Area as this area could be removed when the train has left the area, i.e. before the communication session has been terminated.

Loss of communications is handled by other requirements.

Operational Rules: None

Engineering Rules: None

---



---

REQ-TrackStatus-17	Mandatory	[New]
--------------------	-----------	-------

---



---

When the L3 Trackside considers that the communication session with a train associated with an Unknown Track Status Area is terminated, then the L3 Trackside shall remove the association between the train and that area.

**Rationale:**

Only communicating trains need to be associated with a Track Status Area.

**Guidance:**

This requirement applies in the following situations:

- EoM
- Other reasons for session termination

There is another requirement that changes the status of an Occupied Track Status Area to Unknown before this requirement applies.

Operational Rules: None

Engineering Rules: None

**3.2.2.4 Removing a Track Status Area**

REQ-TrackStatus-18	Mandatory	[New]
--------------------	-----------	-------

When a train has left the L3 Area of Control, the L3 Trackside shall remove the Track Status Area associated with this train.

Rationale:

There is no need to maintain the Track Status Area associated with a train once the train has left the Area of Control.

Guidance:

When there is no longer a Train Location for a train in the Area of Control, i.e. the train has reported with its CRE beyond the border and/or TTD in rear of the border is clear, then the associated Track Status Area can be removed.

However, projects may decide to maintain the Track Status Area somewhat longer, e.g. until the communication session is terminated.

Operational Rules: None

Engineering Rules: None

REQ-TrackStatus-19	Mandatory	[X2R3 D4.2: REQ-TrackStatus-12]
--------------------	-----------	---------------------------------

The L3 Trackside shall automatically remove Sweepable Unknown Track Status Areas for which the extent is less than or equal to a configurable minimum length, except if this Unknown Track Status Area is associated with a Train Location to protect the front end of a train at Start of Mission.

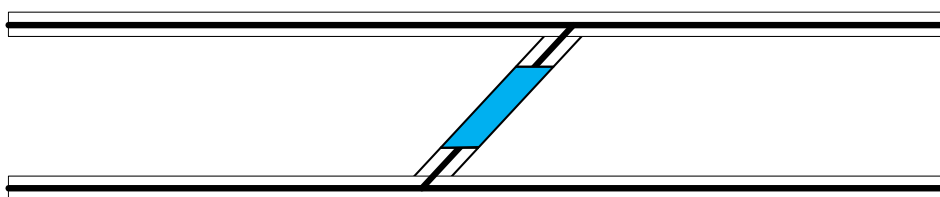
Rationale:

This is to avoid having small Unknown Track Status Areas that have to be swept when it is known that there cannot be a vehicle inside them.

Guidance:

Small Unknown Track Status Areas could arise from splitting and joining procedures, or from sweeping. Unknown Track Status Areas flagged as Non-Sweepable can only be removed at the request of the TMS.

For example, this requirement could apply to cross-over areas, as in Figure 33:



**Figure 33: Short unknown area at crossover**

The configurable minimum length could be related to the length of the shortest vehicle that could be running on the line. The Unknown Track Status Area can be removed, regardless of the status of adjacent areas.

The exception is because the configured distance could be larger than the Unknown Track Status Area created to protect the front of a train at Start of Mission before having received the length of the train from Validated Train Data.

An Unknown Track Status Area created to protect the front end of a train at Start of Mission must not be removed by this mechanism. Instead, this Unknown Track Status Area will increase in extent when Validated Train Data is received, and then changed to Occupied when the train reports with Integrity Confirmed.

In case an Unknown Track Status Area is split in two, e.g. by a clear TTD section, and if one of these areas is shorter than the configured minimum distance, then it can be removed even if it has a Recorded Train Length because that length is also recorded in the other area. Thus, there is no risk of trains and/or waggons becoming lost.

Operational Rules: None  
 Engineering Rules: ENG-Generic-3

---

REQ-TrackStatus-20	Mandatory	[X2R3 D4.2: REQ-TrackStatus-19]
--------------------	-----------	---------------------------------

---

When the L3 Trackside considers the communication session as terminated with a train completely located inside an Active Shunting Area, then the L3 Trackside shall remove the Track Status Area associated with this train.

Rationale:

For a train completely within an Active Shunting Area, protection after EoM will be provided by the Unknown Track Status Area associated with the Shunting Area.

Guidance:

For a train whose location is fully inside an Active Shunting Area when it reports EoM, the Track Status Area associated with the train is removed, since the train is already in an Unknown Track Status Area and the L3 Trackside will not know where the train may move while in SH mode.

This requirement also applies in a degraded situation when the L3 Trackside considers the communication session is terminated without receiving an EoM message from a train inside an Active Shunting Area.

Operational Rules: None  
 Engineering Rules: None

---

REQ-TrackStatus-21	Mandatory	[New]
--------------------	-----------	-------

---

When the L3 Trackside considers the communication session is terminated with a train completely located inside an Activated Temporary Shunting Area, then the L3 Trackside shall add the length of this train to the Recorded Train Length for the Unknown Track Status Area associated with the Shunting Area.

**Rationale:**

This is to be able to decide if there is/are any train(s) left in the Shunting Area when it is deactivated.

**Guidance:**

The train must be completely located inside the Shunting Area for this to apply, otherwise it is not clear what part of the train length to store. However, projects may decide to deal with this differently, e.g. if there is TTD.

This requirement also applies in a degraded situation when the L3 Trackside considers the communication session is terminated without receiving an EoM message from a train inside an Activated Temporary Shunting Area.

Projects may decide to record the Train ID of trains performing EoM within an Activated Temporary Shunting Area with the Unknown Track Status Area associated with the Shunting Area.

Operational Rules: None

Engineering Rules: None

**3.2.2.5 TMS Related Track Status Requirements**

REQ-TrackStatus-22	Mandatory	[X2R3 D4.2: REQ-TrackStatus-6]
--------------------	-----------	--------------------------------

On request from the TMS, the L3 Trackside shall create an Unknown Track Status Area flagged as Sweepable provided the area is longer than the configurable minimum length.

**Rationale:**

This is to allow the L3 Trackside to have all relevant information concerning obstructions.

**Guidance:**

For example, this can be used in the degraded situation of a non-communicating train. A train without communications has to be moved inside an Unknown Track Status Area, so that the L3 Trackside is aware that this area is protected for a specific train.

The Unknown Track Status Area may be created automatically by the TMS, or via dispatcher interaction with the TMS.

Unknown areas can be created independent of the current Track Status in that area, i.e. they can overlap existing areas of Unknown or Occupied.

The Sweepable Unknown Track Status Area needs to be longer than the configurable minimum length for removal of Unknown Track Status Areas, as defined in ENG-Generic-3.

Operational Rules: OPE-TrackInit-2; OPE-Generic-7; OPE-LossComms-1;  
OPE-LossTI-1  
Engineering Rules: ENG-Generic-3

---



---

REQ-TrackStatus-23	Mandatory	[X2R3 D4.2: REQ-TrackStatus-7]
--------------------	-----------	--------------------------------

---



---

On request from the TMS, the L3 Trackside shall create an Unknown Track Status Area flagged as Non-Sweepable.

**Rationale:**

When the TMS requests a Non-Sweepable Unknown Track Status Area, it may be for a reason that would make it unsuitable to be swept e.g. a known permanent obstacle on the line.

**Guidance:**

Non-Sweepable Unknown Track Status Areas will only be cleared at the request of the TMS. The L3 Trackside will retain a Non-Sweepable Unknown Track Status Areas after traversal by a train which has confirmed Train Integrity.

The Unknown Track Status Area may be created automatically by the TMS, or via Dispatcher interaction with the TMS.

Unknown Track Status Areas can be created independent of the current Track Status in that area, i.e. they can overlap existing areas of Unknown or Occupied.

For example, creating Unknown Track Status Areas in parts of the track might be due to external systems detecting fallen objects, or landslides.

Operational Rules: OPE-TrackInit-2, OPE-Generic-7; OPE-LossComms-1;  
OPE-LossTI-1  
Engineering Rules: None

---



---

REQ-TrackStatus-24	Mandatory	[X2R3 D4.2: REQ-TrackStatus-10]
--------------------	-----------	---------------------------------

---



---

On request from the TMS, the L3 Trackside shall remove, reduce or extend Unknown Track Status Areas.

**Rationale:**

L3 Trackside must allow the TMS to remove, reduce or extend Unknown Track Status Areas based on the result of operational procedures.

**Guidance:**

An Unknown Track Status Area, both Sweepable and Non-Sweepable, can be removed, reduced or extended by the TMS.

For example, some Infrastructure Managers may permit Unknown Track Status Areas to be removed or reduced based on the observations of a Driver sweeping on an adjacent line.



Projects may, if providing the necessary information, allow the Dispatcher via TMS to remove or reduce parts of an Unknown Track Status Area, e.g. by stating a certain length to be removed.

In case there is a train length stored for an Unknown Track Status Area requested for removal, it is recommended that the L3 Trackside prevents removing this Unknown area unless the removal is supported by some additional measure(s).

Robust operational procedures are required in order to permit the Dispatcher, via the TMS, to remove or reduce Unknown Track Status Areas.

In case of overlapping Track Status Areas additional conditions might be taken into account when removing an Unknown Track Status Area.

If the Unknown Track Status Area is Sweepable, the L3 Trackside will remove it if it is reduced to a length shorter than the configurable minimum length for removal of Unknown Track Status Areas, as defined in ENG-Generic-3.

Operational Rules: OPE-Generic-2, OPE-Generic-7

Engineering Rules: None

---

REQ-TrackStatus-25	Mandatory	[X2R3 D4.2: REQ-TrackStatus-13]
--------------------	-----------	---------------------------------

---

The L3 Trackside shall report the Track Status for all track within its Area of Control to the TMS.

Rationale:

This is to provide the TMS with information about the Track Status.

Guidance:

This information can be used by the TMS during normal operation, and also to manage degraded situations.

The information reported to the TMS will be dependent on the design of the TMS. As a minimum, it should be the Consolidated Track Status. If the TMS is able to accept more information, it could also include all individual Track Status Areas.

Operational Rules: None

Engineering Rules: None

### 3.2.2.6 Other Track Status Requirements

---

REQ-TrackStatus-26	Mandatory	[X2R3 D4.2: REQ-TrackStatus-9]
--------------------	-----------	--------------------------------

---

If an Unknown Track Status Area is created that is within a Reserved Status Area allocated to a train, then the L3 Trackside shall react to transition the system to a safe state.

Rationale:

A new Unknown Track Status Area within a Reserved Status Area allocated to a train may require urgent action from the L3 Trackside in order to avoid a hazard.

Guidance:

The specific reaction applied will depend on the scenario and application specific requirements. Possible reactions include shortening of the Movement Authority for another train; sending an Unconditional Emergency Stop to one or multiple trains etc.

Operational Rules: None

Engineering Rules: None

REQ-TrackStatus-27	Mandatory	[X2R3 D4.2: REQ-TrackStatus-14]
--------------------	-----------	---------------------------------

The L3 Trackside shall store and update data for all the Track Status Areas within its Area of Control in accordance with the following table:

Data item	Type or Possible Values	Notes
Status	Occupied or Unknown	
Extent	Definition of the extent of the Track Status Area	The extent of the Track Status Area. May contain additional information to relate Extent to Train Location.
Recorded Train Length	As for L_TRAIN	The length of train associated with this Track Status Area, if any. Note this length is not the same as the extent of the area.
Train ID	As for NID_ENGINE	The NID_ENGINE of the train associated with this area, if any.
Reason Unknown	From enumerated list see Table 2.	If the Track Status Area is Unknown, then the reason why it is Unknown. There might be more than one reason.
Sweepable	Boolean	Whether an Unknown Track Status Area is Sweepable or Non-Sweepable.

**Table 9 – Track Status Area Stored Data**

Rationale:

The Stored Data will be used by recovery mechanisms, for example at Start of Mission, recovery after loss of integrity etc.

Stored Information can also aid with initialising the L3 Trackside after a restart.

Guidance:

The Train ID stored will be the NID\_ENGINE from the most recent Train Position Report received for the train associated with the Track Status Area, if any. There may be other NID\_ENGINE values available, for example from SL or NL Train Position Reports. These do not need to be stored, as they were not used to

establish or modify this Track Status Area. However, projects may decide to store the identities of such trains and may also decide to store identities of the train that was associated with the area before EoM, or for trains performing EoM inside an Activated Temporary Shunting Area together with the Unknown Track Status Area associated with the Shunting Area.

A status of a part of the track may be Unknown for more than one reason. Projects may decide to handle this with one Unknown Track Status Area with several reasons for Unknown, or to use separate Unknown Track Status Areas for each reason.

Stored Data for Track Status Area can be used in the following situations:

- a) Joining/Splitting: The Length of trains involved in Splitting and Joining is recorded, and the L3 Trackside ensures that the full length is accounted for before and after the procedure
- b) Start of Mission: Comparing the new train length to the stored train length for an Unknown Track Status Area, and removing the Unknown Track Status Area if the train lengths match
- c) Recovery after loss of communication (new session): New train length received is compared with that stored to check that it is the same train reconnecting.

The enumerated list of reasons for an Unknown Track Status Area will include the reasons listed in Table 2.

Operational Rules: None

Engineering Rules: None

### 3.3 Reserved Status

#### 3.3.1 Introduction

This section contains requirements relating to the reserving of an area of track for the movement of trains by the L3 Trackside. Reserving these areas is based on information from the TMS or the Dispatcher, e.g., by specifying a path from start to end or referencing the identity of a predefined path. The end of such a path is the next target location for the train, i.e., where the train is supposed to go according to the TMS or the Dispatcher depending on the actual traffic situation and operational circumstances. In some situations, e.g., when following another train, the L3 Trackside may not be able to reserve an area all the way to the requested target location. In that case, the L3 Trackside will reserve an area to a suitable intermediate location (e.g., the rear end of the train in front) and when possible, extend the reserved area towards the target location, e.g. in response to an MA-request. Thus, an Occupied Track Status Area can be such an intermediate location, unless the intention is to join trains, while an Unknown area is not and could be swept when passed.

An area of track must be Reserved before the L3 Trackside authorises a train to move within that area to avoid potential conflicts with other trains. Reserved Status Areas prevent trackside

objects in that area, e.g., points, from being moved. All the necessary protections need to be in place before a Reserved Status Area is created or extended, e.g. points in flanks or overlap must be in the requested position, as for locked routes in a Level 2 system.

The state Reserved is separate to the states defined for Track Status.

In normal situations, an area of the track will be Reserved within the L3 Trackside before:

The L3 Trackside sends a Movement Authority to a train for that area of track.

The L3 Trackside sends a Staff Responsible authorisation to a train for that area of track.

The L3 Trackside sends Route Related Information as part of an RBC/RBC handover to an adjacent system.

A Reserved Status Area is the prerequisite for an authorisation within this area but the length of the authorisation given to a train is not necessarily the same as the length of the Reserved Status Area; see the MA and SR requirements for more information on this.

In degraded situations, when it is not possible to establish a Reserved Status Area, the L3 Trackside may still authorise trains to move in SR mode; see REQ-MovSR-1.

### 3.3.2 Requirements

REQ-Reserved-1	Mandatory	[X2R3 D4.2: REQ-Reserved-1]
----------------	-----------	-----------------------------

On request from the TMS, the L3 Trackside shall be able to establish or extend a Reserved Status Area.

Rationale:

Reserved Status Areas are needed for being able to authorise a train to move within the Reserved Status Area.

Guidance:

A Reserved Status Area is directional, reserving a path for a train from the start of the Reserved Status Area to the end.

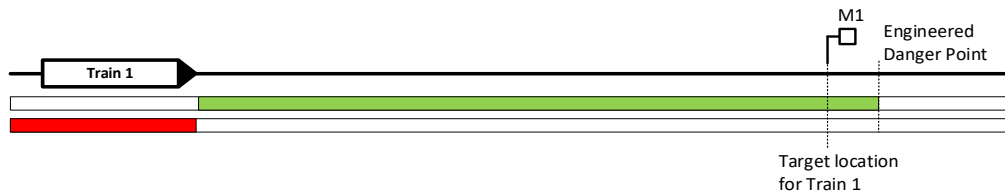
The request from the TMS may come with a start and end for the path intended for a train, or simply with the identity of a predefined path. Anyway, the L3 Trackside uses this information to establish or extend a Reserved Status Area. Projects may decide on rules to reject, delay or only use part of the information, depending on the situation, e.g., conflicts with other Reserved Status Areas and temporary limits like an Occupied Track Status Area or the boundary of an Occupied FVB.

The end of a Reserved Status Area is, if possible, at the target location in the request from the TMS. If applicable, it also includes any Overlap or Danger Point. However, depending on the situation, the L3 Trackside may decide to temporarily end the Reserved Status Area at an intermediate location, e.g., due to conflicts with other Reserved Status Areas when following another train. When the intention is to join with another train, the requested target location should not be

at the beginning of the Track Status Area associated with the train to be joined, because then the joining train may not get close enough to physically join due to the accumulated confidence interval for the position of the train. Instead, the target location should rather be at the end of the train to be joined, but projects may decide differently.

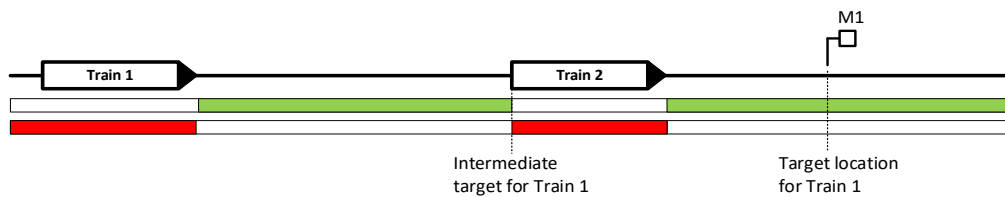
The following figures show some examples of Reserved Status Areas:

- Reserved Status Area to the target location as requested by the TMS:



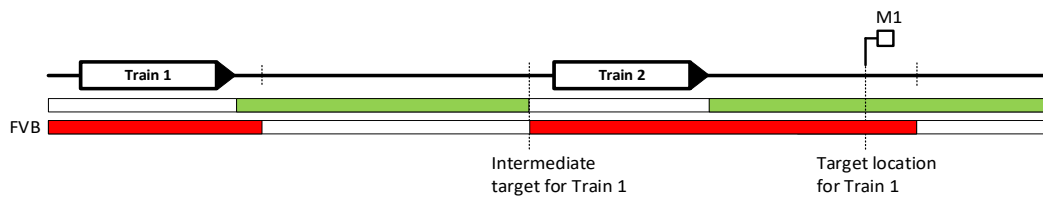
**Figure 34: Reserved Status Area to the target location, including an overlap**

- Reserved Status Area temporarily to an intermediate location:



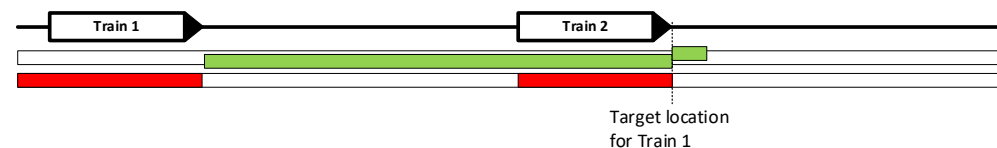
**Figure 35: Reserved Status Area to the rear of a train in front**

- Reserved Status Area temporarily to an FVB border boundary:



**Figure 36: Reserved Status Area to FVB border boundary**

- Reserved Status Area to join with another train:



**Figure 37: Reserved Status Area for Train 1 to join with Train 2**

Operational Rules: None

Engineering Rules: None

REQ-Reserved-2	Mandatory	[New]
----------------	-----------	-------

The L3 Trackside shall prevent that Reserved Status Areas overlap other Reserved Status Areas, except where operationally required.

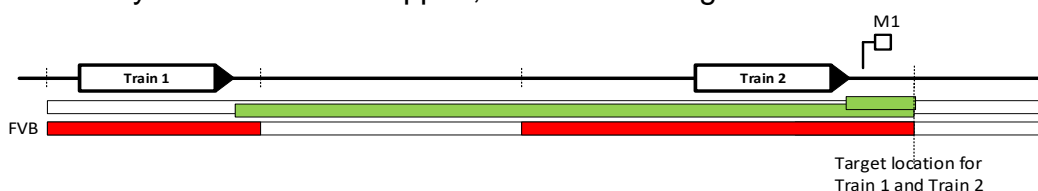
**Rationale:**

This is to prevent conflicts with other authorised train movements due to the risk of collision.

**Guidance:**

In general, Reserved Status Areas cannot overlap.

For joining trains in a Fixed Virtual Block system, as the Reserved Status Area will need to be extended up to a Fixed Virtual Block boundary, Reserved Status Areas may need to be overlapped, as shown in Figure 38.



**Figure 38: Reserved Status Area for Train 1 to join with Train 2 with FVB**

In Figure 38, the Reserved Status Areas for Train 1 and Train 2 have the same target location, at the Fixed Virtual Block boundary. However, projects may find alternative solutions to avoid the overlapping of Reserved Status Areas.

Operational Rules: None

Engineering Rules: None

REQ-Reserved-3	Mandatory	[New]
----------------	-----------	-------

The L3 Trackside shall prevent that Reserved Status Areas cross other Reserved Status Areas or Occupied Track Status Areas.

**Rationale:**

This is to prevent conflicts with other authorised train movements due to the risk of collision in crossings.

**Guidance:**

Reserved Status Areas cannot cross other Reserved Status Areas or Occupied Track Status Areas due to the risk of collision. The TMS may check for this before the L3 Trackside is requested to establish or extend a Reserved Status Area. However, as the track status could have changed since the request was issued, the L3 Trackside must also confirm this.

In case of crossing part of an Unknown Track Status Area, this could result in this part being swept.

Operational Rules: None

Engineering Rules: None

---



---

REQ-Reserved-4	Mandatory	[New]
----------------	-----------	-------

---

The L3 Trackside shall be able to allocate a Reserved Status Area to a train when:

- There is a Train Location for the train, AND
- the Train Location is adjacent to the start of the Reserved Status Area, or is within the Reserved Status Area, AND
- the Train Location is in the same direction as the Reserved Status Area

Rationale:

This is to establish the area where a train is allowed to move without conflicting with the movement of other trains.

Guidance:

A Reserved Status Area is established to allow a train to move within the area, as such the L3 Trackside needs to allocate it to a train. This allocation can be done when the Reserved Status Area is established, or later in case there is not yet a communicating train to allocate it to.

Reserved Status Areas are almost always allocated to a communicating train and thereby the start of the Reserved Status Area is at the front end of the Track Status Area associated with this train. Depending on system type, this could be at the Max Safe Front End (MSFE) as reported by the train or at the boundary of a TTD section.

If there is no train to allocate the Reserved Status Area to, it will start at the location in the request from the TMS. This can happen at entrances to the L3 Area or at RBC/RBC borders before the train the Reserved Status Area is intended for has established a communication session with the L3 Trackside, or if the area is intended to reserve a path for a train which is not able to establish a communication session.

The Reserved Status Area can be allocated to the train as it approaches the start of the Reserved Status Area, or when the train has just entered the Reserved Status Area. This will depend on the frequency of Train Position Reports.

Operational Rules:      None

Engineering Rules:      None

---



---

REQ-Reserved-5	Mandatory	[New]
----------------	-----------	-------

---

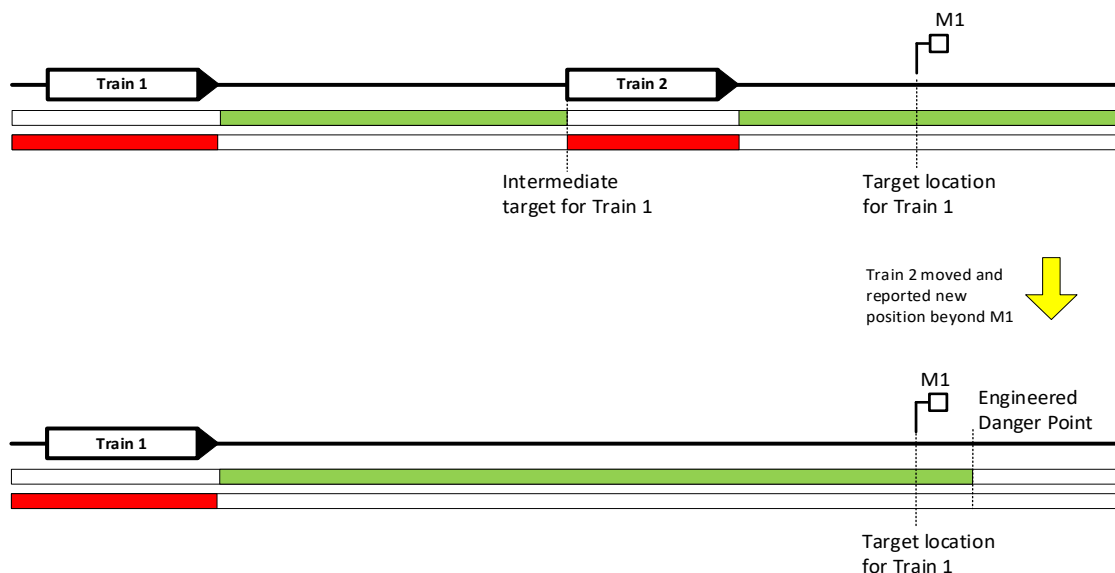
The L3 Trackside shall be able to extend a Reserved Status Area allocated to a train.

Rationale:

This is to enable continuous movement when the target location for the train, as given by the TMS, is not yet included in the Reserved Status Area.

Guidance:

The L3 Trackside must be able to extend a Reserved Status Area if the target location for this train is not yet included in the current Reserved Status Area. The L3 Trackside may decide to automatically extend the Reserved Area depending on how far the current situation allows for extending it e.g. when following another train and the presence of FVB. An MA request may also trigger the extension.



**Figure 39: Reserved Status Area extended to the target location after Train 2 has left**

As a L3 Trackside informs the TMS about the current status, an MA-request from a train may trigger the TMS to request a Reserved Status Area to be established or extended for that train; see REQ-Reserved-1.

Operational Rules: None

Engineering Rules: None

REQ-Reserved-6	Mandatory	[New]
----------------	-----------	-------

When requested to establish or extend a Reserved Status Area into an Occupied Track Status Area, the L3 Trackside shall only do this if the intention is for joining and the train associated with the Occupied area has stopped.

Rationale:

This is to enable joining of trains.

Guidance:

Projects need to decide on how to know when the intention is to join the trains. One possibility to know this is to use a specific request for joining from the TMS or the Dispatcher, because even if two trains have the same target location the intention may not be to join them.



When joining at the front, the train to be joined should have had any remaining authorisation revoked by the L3 Trackside and in most cases it will have performed EOM so the joining will be at an Unknown Track Status Area.

Operational Rules: None

Engineering Rules: None

---

REQ-Reserved-7	Mandatory	[X2R3 D4.2: REQ-Reserved-5]
----------------	-----------	-----------------------------

---

The L3 Trackside shall prevent that a Reserved Status Area is allocated to more than one train.

Rationale:

This is to assure that only one train can be authorised to move within a Reserved Status Area.

Guidance:

Reserved Status Areas are often allocated to a train already when the area is established and it is then allocated to the train at the start of the area. In case there is no train to allocate the area to, this can happen later on, e.g. at borders where a Reserved Status Area can be established before the L3 Trackside has a communication session with the train approaching the border. At RBC/RBC borders, the Reserved Status Area can be allocated to the train preannounced by the Handing Over RBC, even before there is a communication session with this train.

Operational Rules: None

Engineering Rules: None

---

REQ-Reserved-8	Mandatory	[X2R3 D4.2: REQ-Reserved-4]
----------------	-----------	-----------------------------

---

The L3 Trackside shall update the start of the Reserved Status Area for a communicating train when a new Train Position Report is received.

Rationale:

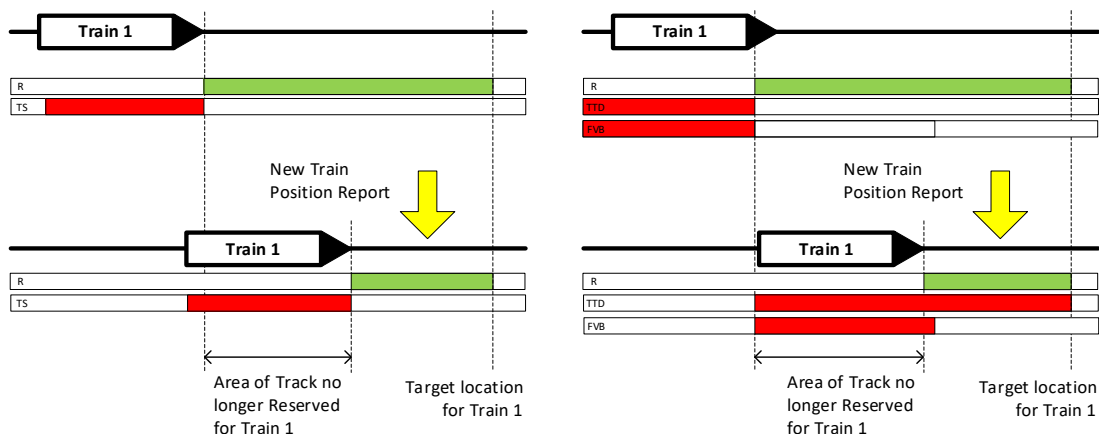
This is required in order for the L3 Trackside to maintain the Reserved Status Areas within its Area of Control.

Guidance:

The Reserved Status Area is adjusted according to the location of the front end of the Track Status Area associated with the train that is allocated to it.

For a system without TTD, this is at the reported location of the Max Safe Front End (MSFE) of the train allocated to the Reserved Status Area. For systems using TTD, this could be adjusted in case the MSFE is in a clear TTD section.

Figure 40 shows the Reserved Status Area update for an individual train:



**Figure 40:: Reserved Status Area update after a new Train Position Report**

The left side shows the updated Reserved Status Area for a system without FVB and TTD, while the right side shows the same update for a system with both FVB and TTD. In the righthand figure, the Reserved Status Area starts at the TTD boundary before the position report, and after the position report it starts at the new MSFE.

The Reserved Status Area could be completely removed, for example after Handover of a train to an adjacent L3 Area, or after the transition of a train into an adjacent area.

Operational Rules: None  
 Engineering Rules: None

REQ-Reserved-9	Mandatory	[X2R3 D4.2: REQ-Reserved-2]
----------------	-----------	-----------------------------

On request from the TMS, the L3 Trackside shall be able to reduce or remove a Reserved Status Area.

Rationale:

The Dispatcher needs the possibility to reduce or remove Reserved Status Areas, e.g. for operational reasons.

Guidance:

The request from the TMS to reduce or remove a Reserved Status Area may come with a new end for the path intended for a train, or simply with the identity of a predefined path. The L3 Trackside uses this information to reduce or remove the Reserved Status Area when it is considered safe to do so.

Operational Rules: None  
 Engineering Rules: None

---



---

REQ-Reserved-10	Mandatory	[X2R3 D4.2: REQ-Reserved-2]
-----------------	-----------	-----------------------------

---



---

The L3 Trackside shall only reduce or remove a Reserved Status Area allocated to a train when this train has no valid authorisation for the part of the Reserved Status Area to be removed.

Rationale:

It is only valid to reduce or remove a Reserved Status Area allocated to a train when the L3 Trackside is sure that it can no longer be used by the train.

Guidance:

How the L3 Trackside decides that it is safe to reduce or remove a Reserved Status Area is project specific and depends on the situation, e.g. before reducing or removing a Reserved Status Area, the L3 Trackside may need to request the train to shorten a given authorisation, as in Level 2 systems.

Operational Rules: None

Engineering Rules: None

---



---

REQ-Reserved-11	Mandatory	[X2R3 D4.2: REQ-Reserved-3]
-----------------	-----------	-----------------------------

---



---

The L3 Trackside shall report the Reserved Status Areas within its Area of Control to the TMS.

Rationale:

This is to enable the TMS to present to the Dispatcher the Reserved Status Area for the movement of every train in the Area of Control.

Guidance:

None.

Operational Rules: None

Engineering Rules: None

---



---

REQ-Reserved-12	Mandatory	[X2R3 D4.2: REQ-Reserved-6]
-----------------	-----------	-----------------------------

---



---

The L3 Trackside shall update the stored data for the Reserved Status Areas in its Area of Control.

Rationale:

Stored Information can aid with initialising the L3 Trackside after a restart.

Guidance:

Stored information about Reserved Status Areas can be used during trackside initialisation to create Unknown Track Status Areas for where trains had been authorised before the system was restarted. This is useful as trains may not have stopped at their last reported position and it may take time before a train is able to reconnect and report a new position.

The stored data may include:

- a) the extent of the Reserved Status Area
- b) the Train ID if any.

In the case of Handover from an adjacent L3 Area, the stored information may be received by the Accepting L3 Trackside from the Handing Over L3 Trackside. In the case of Transition there may also be information received from the adjacent area.

Operational Rules:       None

Engineering Rules:       None

## 3.4 Fixed Virtual Blocks

### 3.4.1 Introduction

This section contains requirements relating to ETCS Level 3 systems which are configured to use Fixed Virtual Blocks.

Fixed Virtual Blocks may be used to provide both:

- a) Predefined areas of track, each with Status Occupied / Clear / Unknown

and:

- b) Predefined locations for the end of Reserved Status Areas.

In a system with Fixed Virtual Blocks, it is necessary to engineer the Fixed Virtual Blocks.

It is assumed that infrastructure elements such as a point end (between the point toe and fouling points) and crossings (between fouling points) are entirely within a single Fixed Virtual Block. For further information, see section 3.6 Points Control.

Each Fixed Virtual Block has a Status, which will be:

- **Occupied**   The Fixed Virtual Block contains all or part of one or more Occupied Track Status Areas
- **Unknown**   The Fixed Virtual Block does not contain any part of an Occupied Track Status Area, but it does contain all or part of one or more Unknown Track Status Areas.
- **Clear**       The Fixed Virtual Block does not contain any part of any Occupied or Unknown Track Status Areas.

All requirements specific to systems using Fixed Virtual Block start with the wording:

“For a system using Fixed Virtual Blocks...”

### 3.4.2 Requirements

REQ-FVB-1	Mandatory	[X2R3 D4.2: REQ-FVB-1]
-----------	-----------	------------------------

For a system using Fixed Virtual Blocks, the L3 Trackside shall determine the Status of all the Fixed Virtual Blocks within the Area of Control by applying the following algorithm:

```

If there is any part of the Consolidated Track Status which is Occupied within
the FVB:
Then
    the FVB has Status Occupied
Elseif there is any part of the Consolidated Track Status which is Unknown
within the FVB
    the FVB has Status Unknown
Else
    the FVB has Status Clear
Endif
    
```

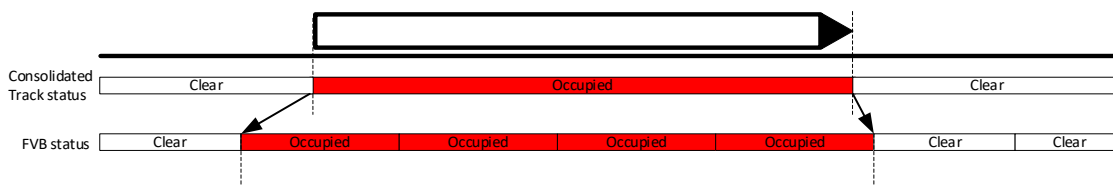
Rationale:

In a system using Fixed Virtual Blocks, Track Status Areas must be determined at the level of Fixed Virtual Blocks. This is required in order for the L3 Trackside to authorise train movement.

Guidance:

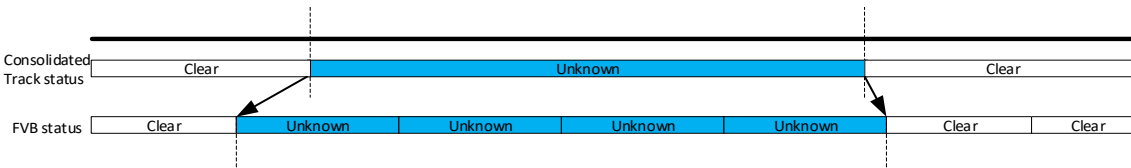
Every Fixed Virtual Block will be Occupied, Unknown or Clear. The algorithm can be considered to be a mapping of the Consolidated Track Status derived through Moving Block principles onto the Fixed Virtual Blocks.

Figure 41 illustrates the derivation for an area of Consolidated Track Status which is Occupied:



**Figure 41: Consolidated Track Status Occupied mapped to Fixed Virtual Block Status**

Figure 42 illustrates the derivation of the Fixed Virtual Block status for an area of Consolidated Track Status which is Unknown:



**Figure 42: Consolidated Track Status Unknown mapped to Fixed Virtual Block Status**

Operational Rules: None

Engineering Rules: None

### 3.5 Trackside Train Detection

#### 3.5.1 Introduction

This section contains requirements relating to ETCS Level 3 systems which are engineered to use Trackside Train Detection (TTD).

The L3 Trackside can operate without TTD. However, some systems may use TTD, and therefore these TTD Requirements are included so that the L3 Trackside can make use of the additional information. The system could be equipped with TTD only in specific locations, or throughout the Area of Control. Part 2 System Definition describes different ETCS Level 3 System Types, with and without TTD.

TTD may be used for the following:

- To detect and permit movement of trains not equipped with TIMS.
- To reduce the performance impact of trains operating without Train Integrity confirmed in the L3 area (either due to loss of integrity or a lack of TIMS equipment being fitted).
- To detect the entry of unfitted trains (trains without ETCS On-board) or other non-communicating railway vehicles at the boundaries of the Area of Control.
- To detect occupation of the track in a Temporary Shunting Area, or in other areas where trains are joined, split, perform EoM.
- To achieve faster release of points and crossings, level crossings etc.
- To assist with faster recovery from degraded situations, to avoid the need for “sweeping” a section of the railway in On Sight mode.

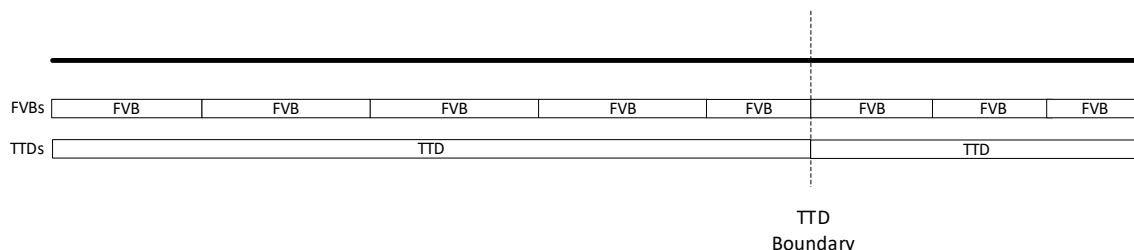
Expected TTD Occupancy in the Requirements below means that a TTD becomes occupied in sequence with an adjacent TTD, and within a Reserved Status Area for a train. All other TTD Occupancy is treated as Unexpected.

TTD status can be used to adjust Train Location, if the change in TTD status can be associated with a train, or to directly create or remove Unknown Track Status Areas.

TTD status can also be used to update Reserved Status Areas.

Infrastructure elements such as points and crossings must be entirely within a single TTD section, as in the railway today.

For ETCS Level 3 systems using Fixed Virtual Blocks, the TTD boundaries must also be Fixed Virtual Block boundaries, as shown in Figure 43:



**Figure 43: Fixed Virtual Blocks with TTD**

All requirements specific to systems using TTD start with the wording:

“For a system using TTD...”

The Requirements for TTD are divided into subsections as follows:

- 3.5.2.1 General TTD Requirements
- 3.5.2.2 Impact of TTD on Train Location
- 3.5.2.3 Impact of TTD on Track Status Areas
- 3.5.2.4 Impact of TTD on Reserved Status Areas

## 3.5.2 Requirements

### 3.5.2.1 General TTD Requirements

REQ-TTD-1	Mandatory	[X2R3 D4.2: REQ-TTD-1]
-----------	-----------	------------------------

For a system using TTD, the L3 Trackside shall manage the lack of synchronisation between TTD status and Train Position Reports for a communicating train.

Rationale:

It will occur that the train physically occupies a TTD before it has reported its position within the TTD boundary (or vice versa). Similarly, the train may physically leave a TTD before it has reported its position beyond the TTD boundary (or vice versa). The L3 Trackside must correlate these events, such that it does not react in an overly restrictive manner to what is normal behaviour.

Guidance:

The L3 Trackside must be designed to allow for:

- A TTD section becoming Occupied by a train before the train has reported a position within the TTD section.
- A train reporting a position within the TTD section before TTD section becomes Occupied.
- A TTD section becoming Clear after a train has left the TTD section before the train has reported a position clear of the TTD section.
- A train reporting a position clear of the TTD section before the TTD section becomes Clear.

The L3 Trackside could use a variety of technical solutions to correlate TTD occupancy to Train Position Reports. For example:

- Sending a Conditional Emergency Stop when a TTD is occupied, to stop a train that is approaching a boundary of the TTD if it is not the one that occupied the TTD.
- Use of a delay timer, to account for lack of synchronisation between Train Position Reports and TTD occupancy. If a train is still not detected when the timer expires, the L3 Trackside would react suitably.

- Tracking of TTD occupancy and correlation with Train Position Reporting, to ensure a normal sequence is observed.

Note: a combination of these techniques may be used, depending on project specific requirements.

Operational Rules: None

Engineering Rules: None

### 3.5.2.2 Impact of TTD on Train Location

REQ-TTD-2	Mandatory	[X2R3 D4.2: REQ-TTD-2]
-----------	-----------	------------------------

For a system using TTD, if the Max Safe Front End reported by a train is located in a clear TTD section while the Min Safe Front End is not in this TTD section, then the L3 Trackside shall shorten the front of the Train Location for this train, by the extent of each TTD section that is detected Clear between the Min Safe Front End and the Max Safe Front End.

Rationale:

TTD information can be used to improve the L3 Trackside knowledge about the status of the track in the Area of Control, thus improving the performance of the system.

Guidance:

The effect of a Clear TTD section in the front part of a Train Location is to update the front of the Train Location.

This can be used to avoid locking points and level crossings in front of the train. Both the reception of TTD status and the receiving of a Train Position Report can be the trigger for updating the Train Location.

Care must be taken to allow for the overhang of vehicles at the boundary between an occupied TTD and a clear TTD.

A clear TTD section in front of a train can shorten the front part of the Train Location of the train, as shown in Figure 44:

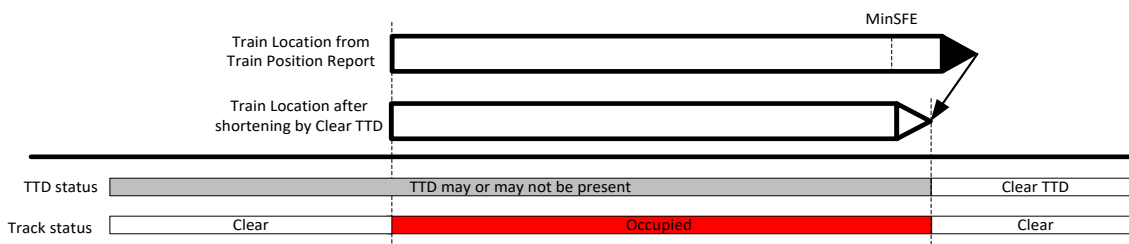
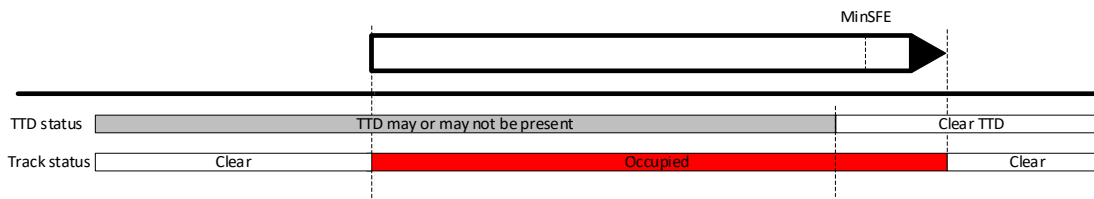


Figure 44: Shortening of front of Train Location due to clear TTD



Figure 45 shows the situation where the Min Safe Front End is reported within the same Clear TTD as the Max Safe Front End, and therefore no shortening:



**Figure 45: No shortening of front of Train Location due to clear TTD**

In this case, projects might be configured to shorten the Train Location up to the Min Safe Front End instead of up to the boundary of the TTD section.

Operational Rules: None  
 Engineering Rules: ENG-Generic-4

REQ-TTD-3	Mandatory	[X2R3 D4.2: REQ-TTD-3]
-----------	-----------	------------------------

For a system using TTD, if the Rear End of the Train Location is located in a clear TTD section while the Max Safe Rear End is not in this TTD section, then the L3 Trackside shall shorten the rear of the Train Location for this train, by the extent of each TTD section that is Clear between the Confirmed Rear End and Max Safe Rear End.

**Rationale:**

TTD information can be used to improve the L3 Trackside knowledge about the status of the track in the Area of Control, thus improving the performance of the system.

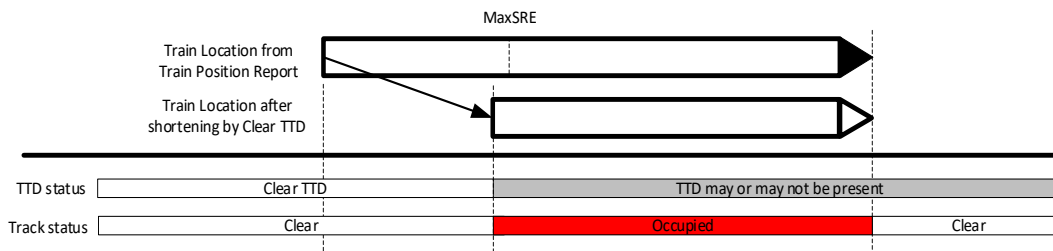
**Guidance:**

The effect of the Clear TTD section in the rear part of the Train Location is to update the rear of the Train Location.

This could be used to release points and level crossings faster. Both the reception of TTD status and the receiving of a Train Position Report can be the trigger for updating the Train Location.

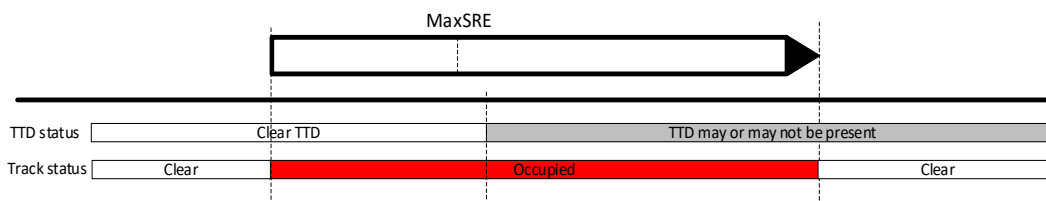
Care must be taken to allow for the overhang of vehicles at the boundary between an occupied and a clear TTD.

A clear TTD section in rear of a train can shorten the rear part of the Train Location of the train, as shown in Figure 46:



**Figure 46: Shortening of rear of Train Location due to clear TTD**

Figure 47 shows the situation where the Max Safe Rear End is reported within the same Clear TTD as the Min Safe Rear End, and there is no shortening:



**Figure 47: No shortening of rear of Train Location due to clear TTD**

In this case, projects might be configured to shorten the Train Location up to the Max Safe Rear End instead of up to the boundary of the TTD section.

Operational Rules: None  
 Engineering Rules: ENG-Generic-4

REQ-TTD-4	Mandatory	[X2R3 D4.2: REQ-TTD-4]
-----------	-----------	------------------------

For a system using TTD, when using Clear TTD sections to shorten a Train Location, the L3 Trackside shall ensure that the length of the reduced Train Location is not shorter than the length of the train.

**Rationale:**

Applying shortening should not result in the extent of the remaining Train Location being less than the length of the train.

**Guidance:**

If the application of shortening the Train Location results in the length of the Train Location being less than the length of the train, it is project specific what alternative action the L3 Trackside takes. For example, an application may decide to not apply any shortening to the Train Location, or to apply equal shortening to the front and rear.

At boundaries, projects might decide to truncate the train location and as a result, Train Location could be shorter than length of the train.

Operational Rules: None  
 Engineering Rules: None

---

---

REQ-TTD-5	Mandatory	[New]
-----------	-----------	-------

---

---

For a system using TTD, when detecting an expected TTD occupancy within the Reserved Status Area allocated to a train, after its Mute Timer has expired, the L3 Trackside shall extend the Train Location of the train up to the closest of:

- the end of the Reserved Status Area, OR
- the next boundary of this Occupied TTD section

**Rationale:**

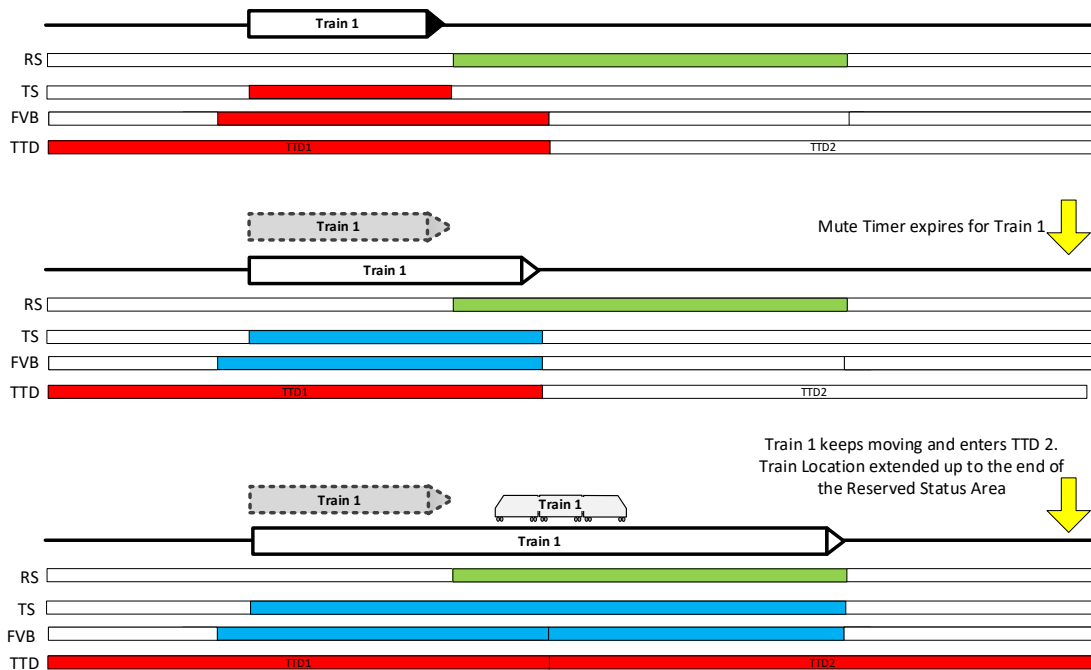
The L3 Trackside can use TTD occupation to extend the Train Location of a train where the Mute Timer has expired and is moving along the railway within the Reserved Status Area allocated to it, thus maintaining the link between the Train Location and the train, thereby facilitating recovery if communication is re-established.

**Guidance:**

The concept of Mute Timer is defined in section 3.11 Loss of Communication.

A train where the Mute Timer has expired can move forward within the Reserved Status Area allocated to that train and occupy a previously clear TTD. That occupation can be attributed to a normal train movement. The L3 Trackside can adjust the knowledge about where the train might be by extending the Train Location of this train.

Figure 48 shows how the Train Location is extended within an already Reserved Status Area when a train proceeds into a previously clear TTD after a loss of communication.



**Figure 48 Extension of Unknown after Mute Timer has expired by Occupied TTD**

Operational Rules: None  
 Engineering Rules: None

REQ-TTD-6	Mandatory	[New]
-----------	-----------	-------

For a system using TTD, when a train is within a Radio Hole, and when detecting an expected TTD occupancy, the L3 Trackside shall extend the Train Location of the train up to the closest of:

- the end of the Radio Hole, OR
- the next boundary of this Occupied TTD section

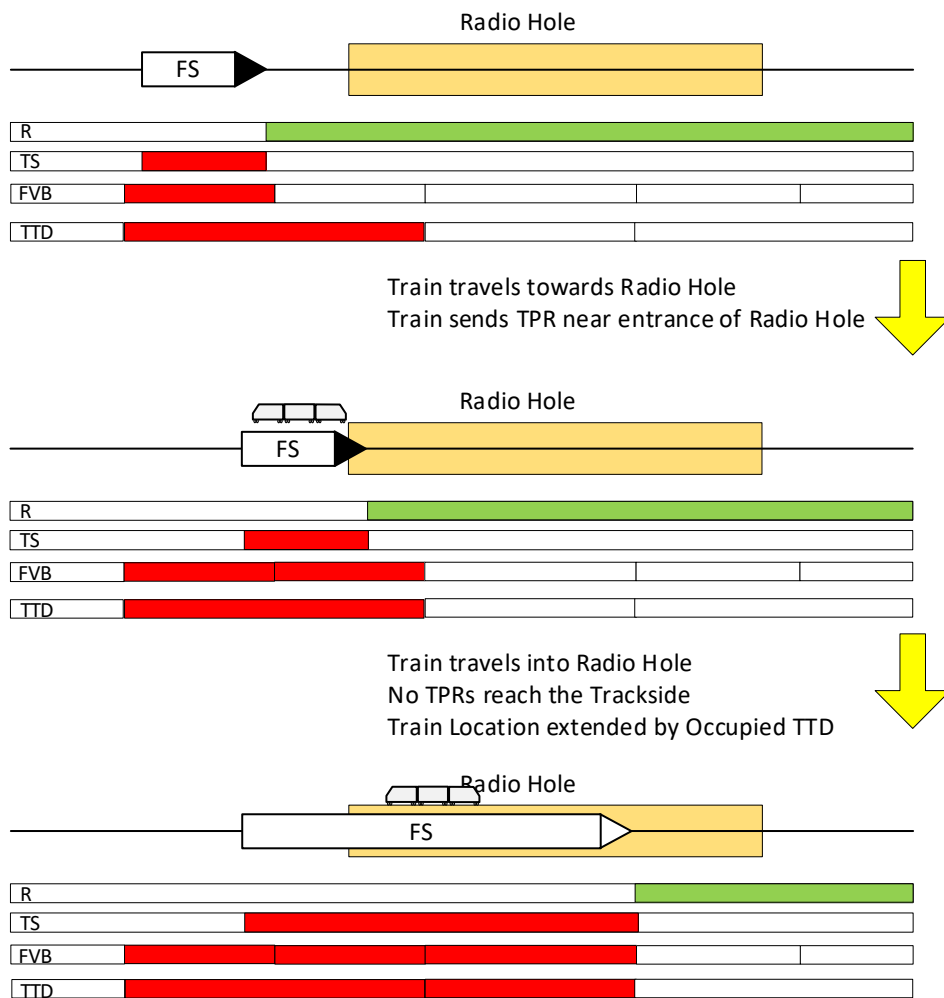
Rationale:

The L3 Trackside can use TTD occupation to extend the Train Location of a train which is within a Radio Hole.

Guidance:

For a system using TTD, a train which is within a Radio Hole will move forward within the Reserved Status Area allocated to that train and may then occupy a previously clear TTD. As a Radio Hole is treated as an EoA Exclusion Area, the Reserved Status Area will extend beyond the end of the Radio Hole.

Figure 49 shows how the Train Location of a train is extended within a Radio Hole, when the train proceeds into a previously clear TTD within the Radio Hole.



**Figure 49: Extension of Train Location within Radio Hole by Occupied TTD**

An Occupied TTD in front of the train also has an impact on the Reserved Status Area. See 3.5.2.4.

There are other requirements relating to clear TTD in rear of the train, and unexpected TTD occupancy.

Operational Rules: None

Engineering Rules: None

### 3.5.2.3 Impact of TTD on Track Status Areas

REQ-TTD-7	Mandatory	[X2R3 D4.2: REQ-TTD-5]
-----------	-----------	------------------------

For a system using TTD, the L3 Trackside shall remove all or part of a Sweepable Unknown Track Status Area which is not associated with a communicating train, corresponding to a TTD section which is Clear.

**Rationale:**

TTD information can be used to clear the track under degraded situations.

**Guidance:**

TTD can assist with recovery as there is no need to sweep clear TTD sections.

Only the part of the Unknown Track Status Area corresponding to the Clear TTD section can be removed according to this requirement. This might mean that part of the Unknown Track Status Area may remain.

Operational Rules: None

Engineering Rules: None

REQ-TTD-8	Mandatory	[New]
-----------	-----------	-------

For a system using TTD, if the L3 Trackside has shortened the extent of an Unknown Track Status Area, the L3 Trackside shall ensure the resulting Unknown Track Status Area is not shorter than the Recorded Train Length stored for it.

**Rationale:**

Applying shortening could result in the extent of the remaining Unknown Track Status Area being less than the Recorded Train Length.

A Track Status Area with an extent shorter than the stored train length could represent a hazard.

**Guidance:**

When the application of shortening the Unknown Track Status Area results in the length of the Unknown Track Status Area being less than Recorded Train Length, it is project specific what alternative action the L3 Trackside takes. For example, an application may decide to not apply any shortening to the Unknown Track Status Area, or to apply equal shortening to the front and rear whilst maintaining the length of the Recorded Train Length.

If an Unknown Track Status Area is one part of an Unknown Track Status Area which has been split, for example by a clear TTD, then project-specific rules may be needed, as the Recorded Train Length will be recorded in two Unknown Track Status Areas. See REQ-TrackStatus-11.

Operational Rules: None

Engineering Rules: None

---



---

REQ-TTD-9	Mandatory	[X2R3 D4.2: REQ-TTD-7]
-----------	-----------	------------------------

---



---

For a system using TTD, when detecting an unexpected TTD occupancy not adjacent to an existing Unknown Track Status Area, or adjacent to an existing Unknown Track Status Area which has zero Recorded Train Length, the L3 Trackside shall create a Sweepable Unknown Track Status Area for that TTD section.

**Rationale:**

A TTD occupancy not associated with any expected train movement should be considered a potential hazard.

**Guidance:**

Unexpected TTD occupancy also includes a TTD remaining Occupied when it might be expected to become Clear. For example, a TTD remaining Occupied behind a train which has sent a Train Position Report which gives a position clear of the TTD might indicate the presence of a Ghost Train. Implementation of such a function is project-specific and will likely require the use of a timer to compensate for the latency between Train Position Reports and TTD inputs.

If the TTD section is a short TTD section protecting a boundary of the L3 Trackside Area of Control, then projects may decide to create a larger Unknown Track Status Area if the TTD becomes unexpectedly occupied. This would require engineering, to determine the size of the Unknown Track Status Area to be created if the short boundary TTD becomes unexpectedly occupied.

There are other requirements relating to reactions for expected TTD occupancy.

Operational Rules: None

Engineering Rules: None

---



---

REQ-TTD-10	Mandatory	[New]
------------	-----------	-------

---



---

For a system using TTD, when detecting an unexpected TTD occupancy adjacent to an existing Unknown Track Status Area which has a Recorded Train Length greater than zero, the L3 Trackside shall extend the Unknown Track Status Area up to the next boundary of this TTD section.

**Rationale:**

A TTD occupancy not associated with any expected train movement should be considered a potential hazard.

**Guidance:**

A train which is not communicating can move and occupy a previously clear TTD. That occupation can be attributed to the train in the adjacent TTD. The L3 Trackside can adjust the knowledge about where the train might be by extending the existing Unknown Track Status Area.

Unexpected TTD occupancy also includes a TTD remaining Occupied when it might be expected to become Clear. For example, a TTD remaining Occupied behind a train which has sent a Train Position Report which gives a position clear of the TTD might indicate the presence of a Ghost Train. Implementation of such a function is project-specific and will likely require the use of a timer to compensate for the latency between Train Position Reports and TTD inputs.

There are other requirements relating to reactions for expected TTD occupancy.

Operational Rules: None

Engineering Rules: None

---

REQ-TTD-11	Optional	[X2R3 D4.2: REQ-TTD-6]
------------	----------	------------------------

---

For a system using TTD, on request from the TMS, the L3 Trackside shall be able to remove an Unknown Track Status Area caused by a faulty TTD.

Rationale:

This will allow the L3 Trackside to help restore normal operation on the line.

Guidance:

This function could be used to improve the reliability of the system and overrule false occupation reported by TTD (e.g. malfunctioning axle counters).

In L3 operation, when all train movements are supervised by ETCS On-board with train position reporting and train integrity confirmation, a faulty TTD could be detected, e.g. dependent on the states of the neighbouring TTDs and position reports.

The implementation of this requirement will need to prevent a new Unknown Track Status Area being created whilst the TTD remains Occupied.

Operational Rules: OPE-Generic-1, OPE-Generic-2

Engineering Rules: ENG-Generic-7

---

REQ-TTD-12	Mandatory	[New]
------------	-----------	-------

---

For a system using TTD, when detecting an unexpected TTD clearance, the L3 Trackside shall react to protect the system.

Rationale:

A TTD clearance which cannot be associated with any regular train movement or train location, should be considered a potential hazard, as such the L3 Trackside needs to protect other train movements by either creating or extending Unknown Track Status Areas.

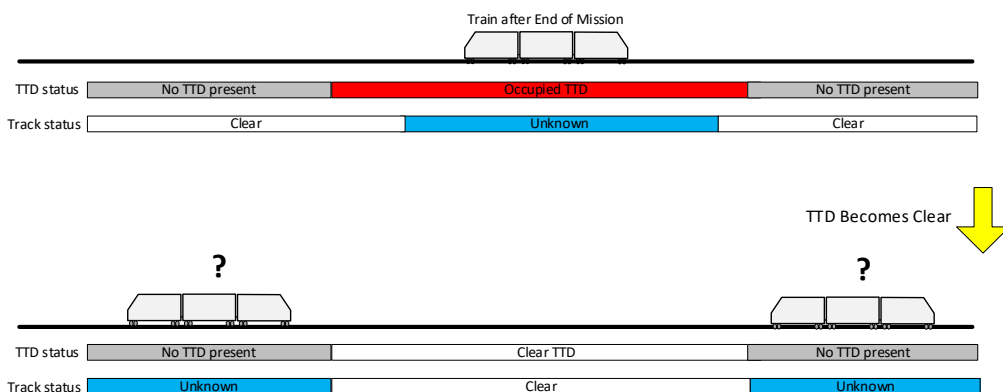
Guidance:

A TTD becoming unexpectedly clear might be due to several reasons. For example a non-communicating train is moved such that the TTD becomes clear.



The L3 Trackside must react, for example by creating an additional Unknown Track Status Areas, or extending existing ones, to protect the movement of trains.

Figure 50 shows the creation of Unknown Track Status Areas adjacent to a Clear TTD which has become unexpectedly Clear.



**Figure 50: Creation of Unknown Track Status Area for unexpected Clear TTD**

Projects should consider the impact of creation or extension of the Unknown Track Status Areas on railway operations.

Depending on the implementation, project-specific engineering rules may be required.

- Operational Rules: None
- Engineering Rules: None

**3.5.2.4 Impact of TTD on Reserved Status Areas**

REQ-TTD-13	Mandatory	[New]
------------	-----------	-------

For a system using TTD, if there is a Clear TTD section in the rear of the Reserved Status Area allocated to a train where the Mute Timer has expired, then the L3 Trackside shall shorten the rear of the Reserved Status Area up to the boundary of the Clear TTD section.

Rationale:

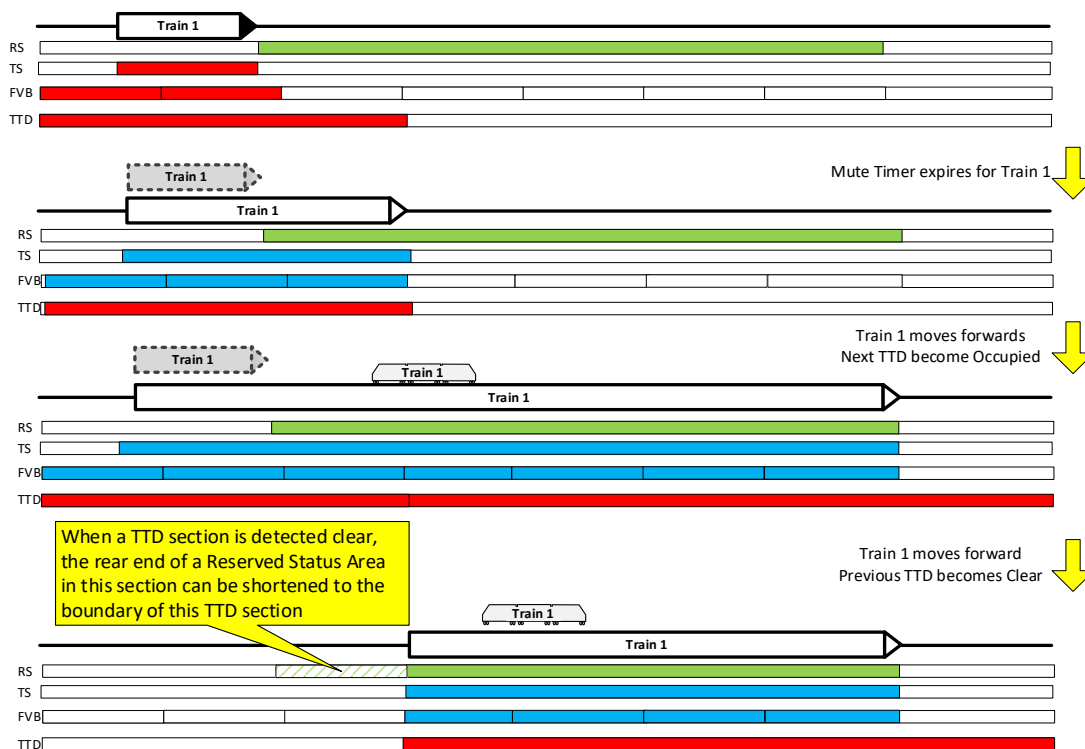
L3 Trackside can use TTD information to adjust the rear of a Reserved Status Area to clear the line under degraded situations.

Guidance:

The concept of Mute Timer is defined in section 3.11 Loss of Communication.

With TTD, when a train which is not communicating still moves forward within the Reserved Status Area allocated to that train, the rear part of the Reserved Status Area over a clear TTD can be shortened, so that the track within this TTD can be used for another train.

Figure 51 illustrates this case. Note that the dashed Train 1 is the last reported position derived from a Train Position Report, while the information about this train remains with the Train Location of the train.



**Figure 51: Shortening of rear of Reserved Status Area due to clear TTD**

Operational Rules: None  
 Engineering Rules: None

REQ-TTD-14	Mandatory	[New]
------------	-----------	-------

For a system using TTD, if the front of the Train Location is extended by an Occupied TTD, then the L3 Trackside shall move the rear of the Reserved Status Area up to the boundary of this TTD section.

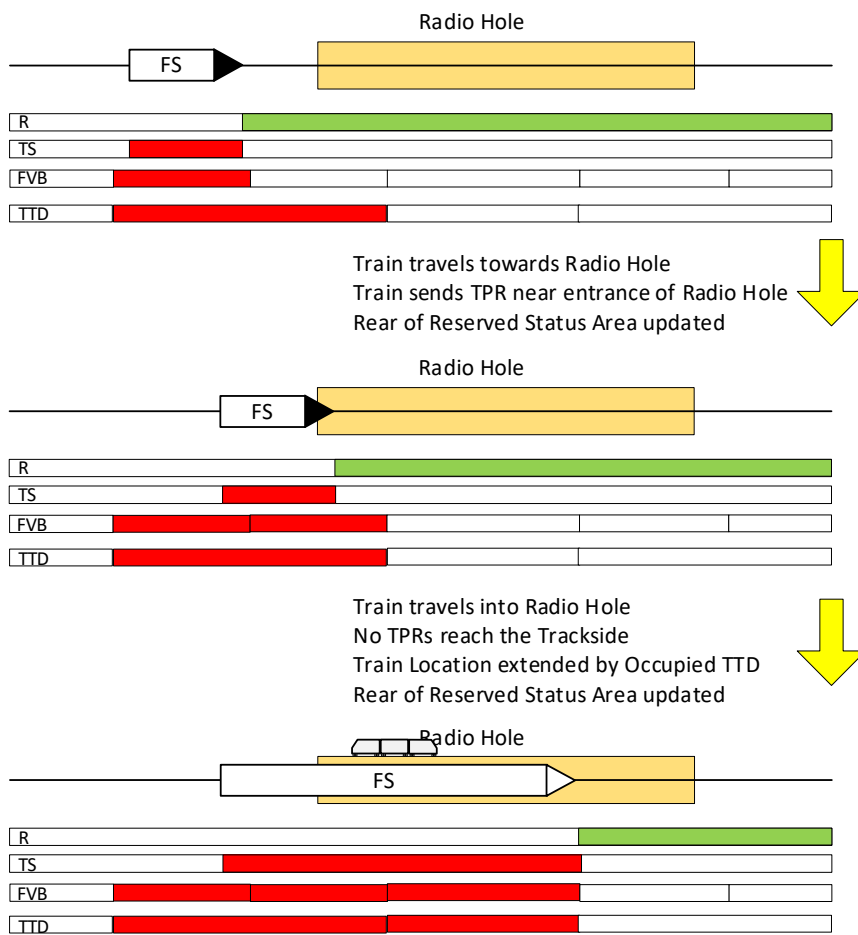
Rationale:

L3 Trackside can use TTD status to update the rear of a Reserved Status Area.

Guidance:

With TTD, when a train moves forward within a Radio Hole, TTDs can be used to track the train, and the rear of the Reserved Status Area allocated to that train can be updated based on the train location determined from the TTDs.

Figure 52 illustrates this case.



**Figure 52: Shortening of rear of Reserved Status Area due to Occupied TTD in Radio Hole**

An Occupied TTD in front of the train also has an impact on the Train Location. See 3.5.2.2.

- Operational Rules: None
- Engineering Rules: None

### 3.6 Points Control

#### 3.6.1 Introduction

This section contains requirements relating to the points or other moveable infrastructure, and crossings or other areas where train movements may conflict without moveable infrastructure.

This section primarily looks at points which provide for the divergence or convergence of train movements. The following requirements are designed to prevent moveable infrastructure being operated whilst occupied by a train and to determine when it is safe for a train to pass through each of the routes through the points, with no conflicting vehicle on the other route.

A crossing where trains can take different routes, often referred to as slips, are a combination of point elements and a crossing element which physically overlap in order to reduce space.

The same principles can apply to a crossing where two routes cross without the ability to select the path the train will take. The following requirements are to prevent two trains being

authorised through the crossing and to confirm that it is safe to pass through the crossing without a conflict. The crossing may include moveable infrastructure which does not allow the routing of trains.

Points will be controlled by the L3 Trackside in the normal way, for example by the setting of Routes, as in a Level 2 system.

This section contains additional requirements for L3 relating to the locking of Points and Crossings, the override procedure required to move points if they are locked, and the impact of sweeping on Points and Crossings.

Points and Crossings are locked by Track Status of Occupied or Unknown.

Points and Crossings are locked by Reserved Status over the Points or Crossing.

For a Full Moving Block system, without Trackside Train Detection, a Locking Area is defined by engineered Release Points. The Release Points must be at or beyond the Fouling Points and Point Toe, as shown in Figure 53 for Points and Figure 54 for Crossings.

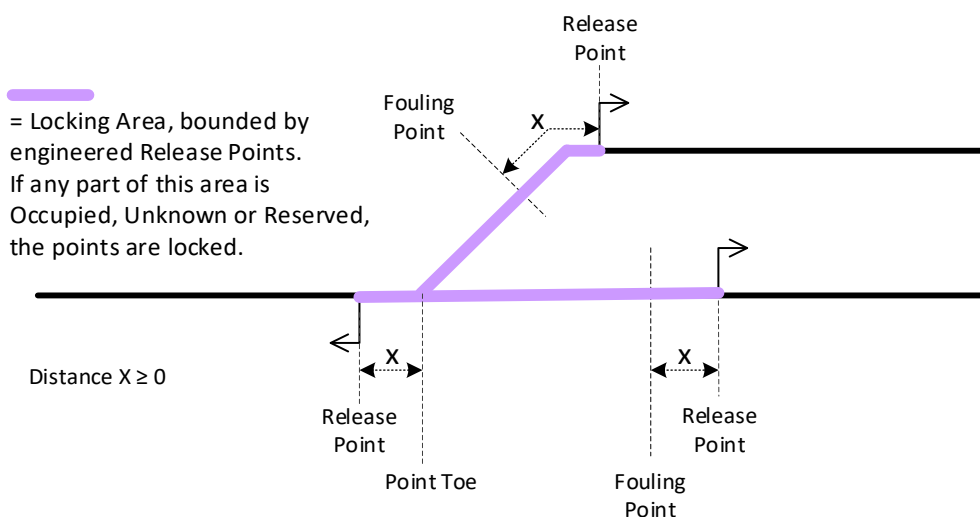
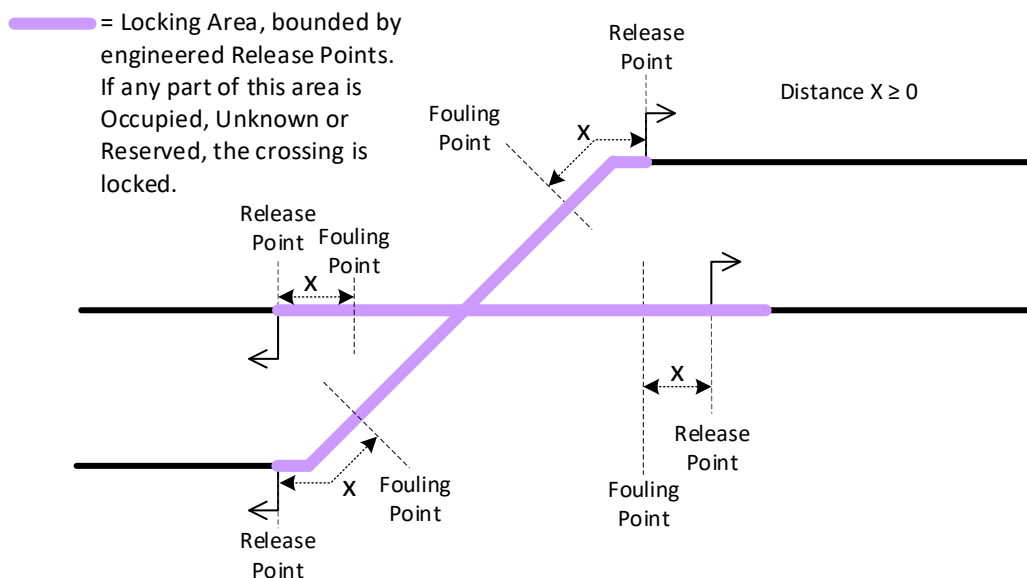


Figure 53: Locking Area for Points in Full Moving Block



**Figure 54: Locking Area for Crossing in Full Moving Block**

The inclusion of a margin, shown as “X” in the figures, would provide protection for the Points or Crossing in the event of rollback of trains.

- If any part of the Locking Area has Occupied or Unknown Track Status, then the points are locked.  
There is an optional exception to this, if it is required that sweeping one leg of the points automatically unlocks the other leg of the points for movement of the points.
- If any part of the Locking Area has Reserved Status, then the points are locked.

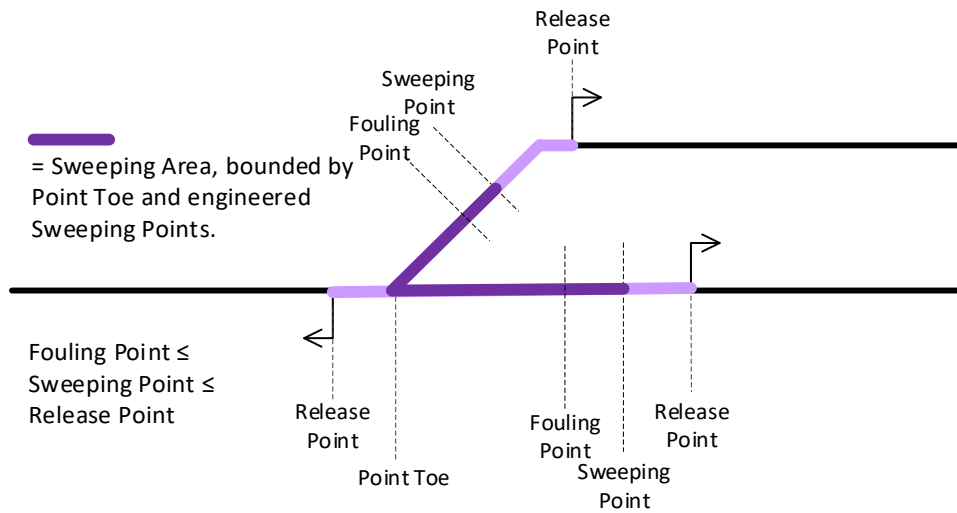
For a Full Moving Block system with Trackside Train Detection (TTD) over the Points:

- If the TTD section over the points is Occupied, then the points are locked.
- If any part of the TTD section has Reserved Status, then the points are locked.

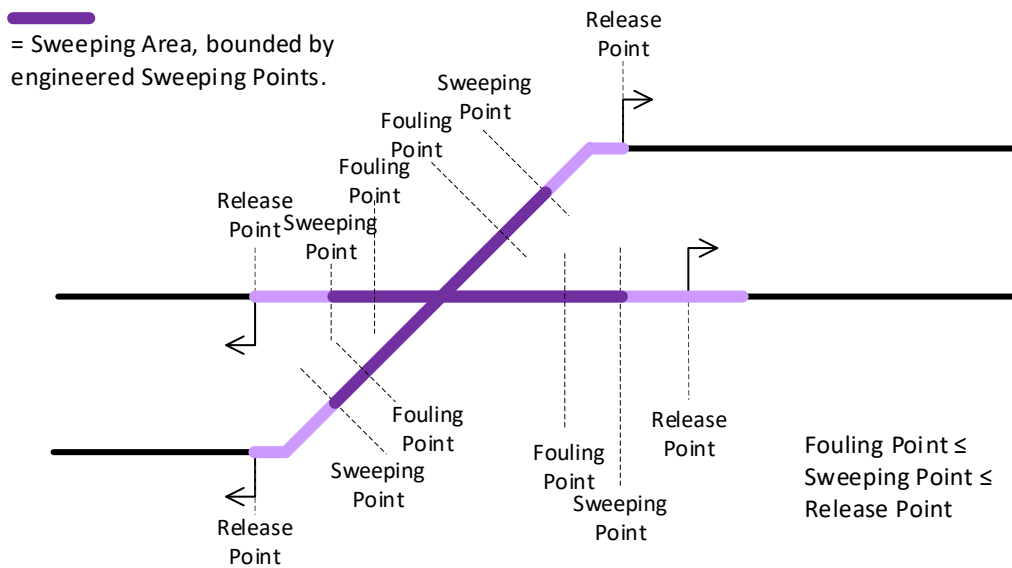
For a Fixed Virtual Block system, with or without Trackside Train Detection, there must be at least one Fixed Virtual Block engineered to cover the Locking Area as defined for Full Moving Block.

- If the Fixed Virtual Block is Occupied or Unknown, then the points are locked.
- If any part of the Fixed Virtual Block has Reserved Status, then the points are locked.

For a Full Moving Block system, without Trackside Train Detection, a Sweeping Area is defined by engineered Sweeping Points. The Sweeping Points can be at the Fouling Points, the Release Points, or in between, as shown in Figure 55 for Points and Figure 56 for Crossings.



**Figure 55: Sweeping Area for Points in Full Moving Block**



**Figure 56: Sweeping Area for Crossing in Full Moving Block**

The behaviour of locking for Points and Crossings is thus dependent on Engineering rules.

### 3.6.2 Requirements

REQ-PTS-1	Mandatory	[X2R3 D4.2: REQ-PTS-1]
-----------	-----------	------------------------

The L3 Trackside shall prevent unintentional movement of points or crossings within a Locking Area when there is any part of an Unknown or Occupied Track Status Area within the Locking Area.

**Rationale:**

To avoid an unintentional point or crossings movement while there is a train over them. For points or crossings within an Active Shunting Area, there will be intentional movements of the elements within the Unknown Track Status Area for the Active Shunting Area.

**Guidance:**

For a Full Moving Block system, the Locking Area is defined by Release Points, which are defined by Engineering.

For a system with Fixed Virtual Blocks, the Release Points will define Fixed Virtual Block boundaries.

For a system with a TTD section covering the Locking Area, the TTD will be used to determine the Track Status.

There is potentially an exception to this requirement if the optional requirement to unlock points after sweeping is used.

Operational Rules: None

Engineering Rules: ENG-PTS-1; ENG-PTS-2

REQ-PTS-2	Mandatory	[X2R3 D4.2: REQ-PTS-1]
-----------	-----------	------------------------

The L3 Trackside shall prevent unintentional movement of points or crossings within a Locking Area when there is any part of a Reserved Status Area within the Locking Area.

**Rationale:**

To avoid an unintentional point or crossings movement while there is a train about to pass over them.

**Guidance:**

For a Full Moving Block system, the Locking Area is defined by Release Points, which are defined by Engineering.

For a system with Fixed Virtual Blocks, the Release Points will define Fixed Virtual Block boundaries.

Operational Rules: None

Engineering Rules: ENG-PTS-1; ENG-PTS-2

REQ-PTS-3	Mandatory	[X2R3 D4.2: REQ-PTS-3]
-----------	-----------	------------------------

On request from the TMS and if other safety conditions are met, the L3 Trackside shall move points or crossings which are within a Locking Area which is locked by a Track Status Area.

**Rationale:**

In order to allow the TMS to move a train to a different location in a degraded situation, it may be necessary for the L3 Trackside to move the elements which are locked by Track Status Area which is Unknown or Occupied.

**Guidance:**

For a Full Moving Block system, the Locking Area is defined by Release Points, which are defined by Engineering.

For a system with Fixed Virtual Blocks, the Release Points will define Fixed Virtual Block boundaries.

If Trackside Train Detection is present at the points or crossings, then this may be used to determine if the area over them is free from railway vehicles.

The TMS may request to move points or crossings that are in an Unknown or Occupied Track Status Area. For an MA to be issued with OS mode profile the points or crossings must be locked and detected. If this is not possible, an SR movement would be required instead.

Operational Rules: OPE-Generic-8

Engineering Rules: None

REQ-PTS-4	Mandatory	[X2R3 D4.2: REQ-PTS-4]
-----------	-----------	------------------------

When a train is sweeping a Point or a Crossing, the L3 Trackside shall remove or reduce a Sweepable Unknown Track Status Area from the Sweeping Area of the alternate leg of the Points or Crossing, in addition to the path taken by the train.

**Rationale:**

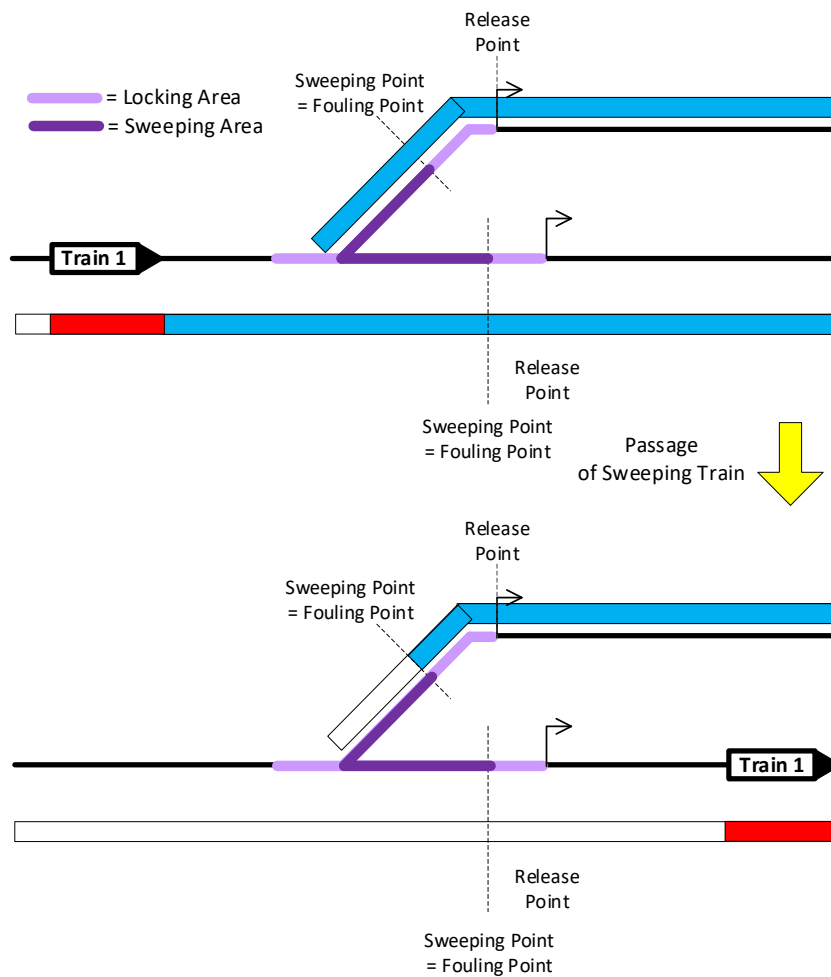
The passing train will ensure that part of the alternative leg(s) is clear.

**Guidance:**

The Sweeping Area is defined by Sweeping Points, which are defined by Engineering. The Sweeping Points may be positioned at the Fouling Points, or at the Release Points, or in between.

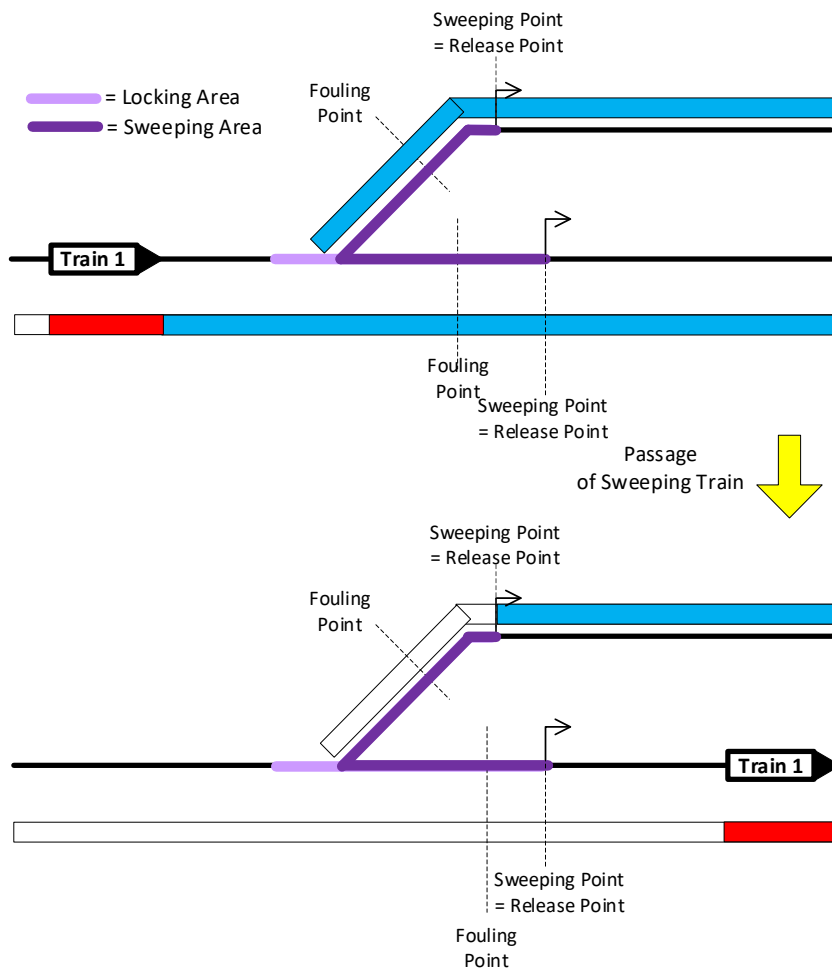


Figure 57 shows the passage of a Sweeping train through set of points in an Unknown Track Status Area in a Full Moving Block system, where the Sweeping Point is engineered at the Fouling Point:



**Figure 57: Passage of Sweeping train across Points – Sweeping Point at Fouling Point**

Figure 58 shows the passage of a Sweeping train through a set of points in an Unknown Track Status Area in a Full Moving Block system, where the Sweeping Point is engineered at the Release Point:



**Figure 58: Passage of Sweeping train across Points – to Release Point**

The same engineering is required for the sweeping area of Crossings.

Operational Rules: None  
 Engineering Rules: ENG-PTS-3; ENG-PTS-4

REQ-PTS-5	Optional	[New]
-----------	----------	-------

When a train is sweeping Points or Crossings, the L3 Trackside shall, if configured, be able to remove the locking on the Points or Crossing after sweeping.

**Rationale:**

After the points or crossing have been swept, Infrastructure Managers may wish for the whole Locking Area to be unlocked without further intervention by personnel, even if there is some Unknown Track Status Area remaining within the Locking Area.

Guidance:

The Sweeping Area is defined by Sweeping Points, which are defined by Engineering. The Sweeping Points may be positioned at the Fouling Points, or at the Release Points, or in between.

If the Sweeping Area is engineered to be smaller than the Locking Area, there may be some Unknown Track Status Area remaining within the Locking Area, after one leg of the points have been swept.

Operational Rules:       None

Engineering Rules:       ENG-PTS-5

### 3.7 Movement Authorities

#### 3.7.1 Introduction

This section is about providing a Movement Authority for a train.

The Movement Authority can only be established or extended if there is a Reserved Status Area allocated to the train and can only be given within the limits of the Reserved Status Area.

#### 3.7.2 Requirements

REQ-MA-1	Mandatory	[X2R3 D4.2: REQ-MA-1]
----------	-----------	-----------------------

The L3 Trackside shall only issue a Movement Authority to a train when there is a Train Location for the train.

Rationale:

The L3 Trackside must know where a train is before it can provide it with a Movement Authority.

Guidance:

None

Operational Rules:       None

Engineering Rules:       None

REQ-MA-2	Mandatory	[X2R3 D4.2: REQ-MA-2]
----------	-----------	-----------------------

The L3 Trackside shall only issue a Movement Authority to a train allocated to a Reserved Status Area, and within the limits of the Reserved Status Area.

Rationale:

The track must be reserved for a train within the L3 Trackside before a Movement Authority can be issued to that train because the Reserved Status Area is the area protected from other train movements.

Guidance:

Movement Authorities are given within a Reserved Status Area but do not need to be to the end of the Reserved Status Area, for example if the length of the Movement Authority is limited by Engineering Rules.

When the Movement Authority is to the end of the Reserved Status Area, the Danger Point will be at the end of the Reserved Status Area.

The End of Authority (EoA) will be dependent on what is at the end of the Reserved Status Area. For example:

- If the end of the Reserved Status Area is at the end of a path, then there may be an engineered D\_DP which should be used to determine the EoA.

This is shown in Figure 59 and Figure 60.



Figure 59: EoA with engineered D\_DP, Full Moving Block

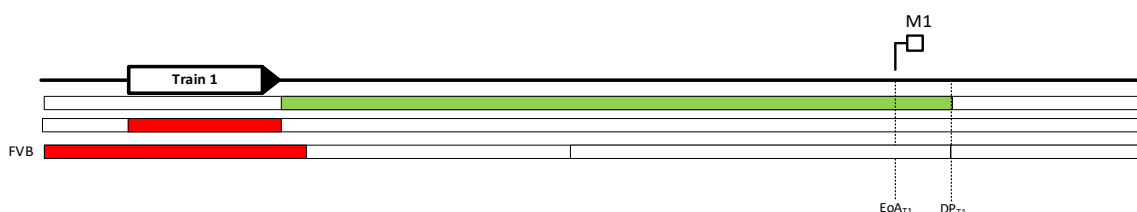


Figure 60: EoA with engineered D\_DP, Fixed Virtual Blocks

- If the end of the Reserved Status Area is at the entry of an Occupied or Unknown Track Status Area, then the engineered L3 Margin may be used to determine the EoA.

This is shown in Figure 61.

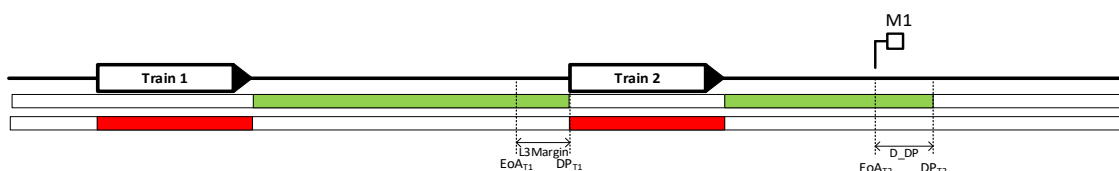
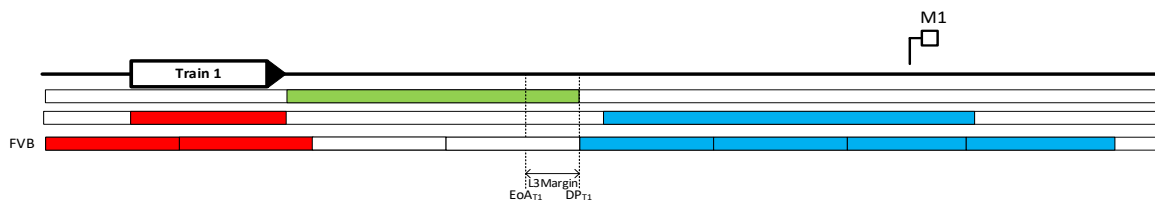


Figure 61: EoA with L3 Margin for D\_DP, Full Moving Block

- If the end of the Reserved Status Area is at the entry of an Occupied or Unknown Fixed Virtual Block, then the engineered L3 Margin may be used to determine the EoA.

This is shown in Figure 62.



**Figure 62: EoA with L3 Margin for D\_DP, Fixed Virtual Blocks**

When the EoA of a Movement Authority is more than the engineered L3 Margin before the end of the Reserved Status Area, then there is no need to separate the EoA from the Danger Point but this is a project decision.

Operational Rules: None

Engineering Rules: ENG-Generic-5

REQ-MA-3	Mandatory	[X2R3 D4.2: REQ-MA-6]
----------	-----------	-----------------------

If a Movement Authority includes Unknown or Occupied areas of track which were present when the Reserved Status Area was established, then the L3 Trackside shall include an On Sight mode profile over each such area within the Reserved Status Area allocated to the train.

**Rationale:**

Unknown Track Status Areas may contain railway vehicles or other obstructions, so it is necessary for trains to proceed in On Sight mode.

Occupied Track Status Areas will contain at least one train, so it is necessary for trains to proceed in On Sight mode.

**Guidance:**

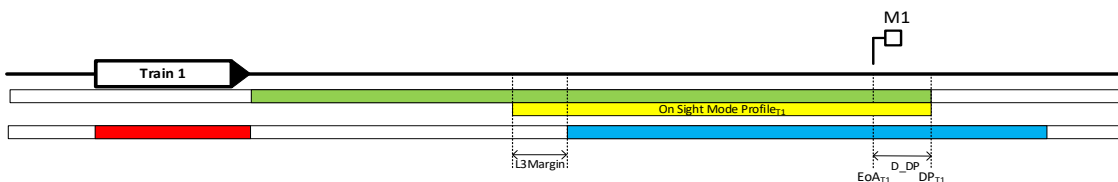
For the case where there is an Unknown or Occupied area of track which was not present when the Reserved Status Area was established, see REQ-MA-7 and REQ-MA-8.

The passage of a train in On Sight mode, over a Sweepable Unknown Track Status Area, results in sweeping the track. The track will become Clear after the passage of a train with Train Integrity confirmed.

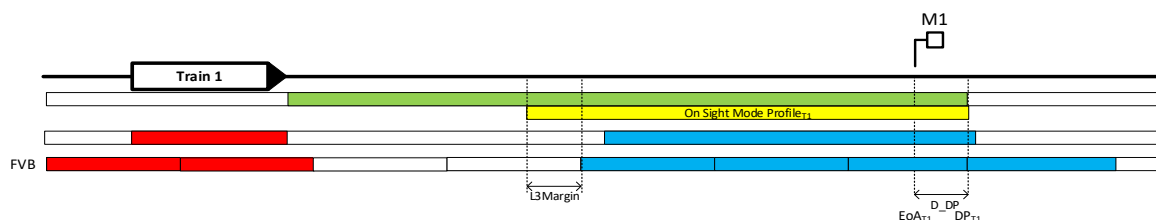
Extension of a Movement Authority in On Sight mode over an Occupied Track Status Area may be required in order to perform joining of trains. The location of the EoA when being authorised into an Occupied Track Status Area is project specific but should be such that it does not overlap with another Reserved Status Area (for example that of a Train to be Joined).

If risk assessment determines that there is a risk of rollback of a vehicle from within the Occupied or Unknown Track Status Area, then the On Sight mode profile may start from a distance of at least the engineered L3 Margin before the boundary of the Occupied or Unknown Track Status Area.

This is shown in Figure 63 and Figure 64.

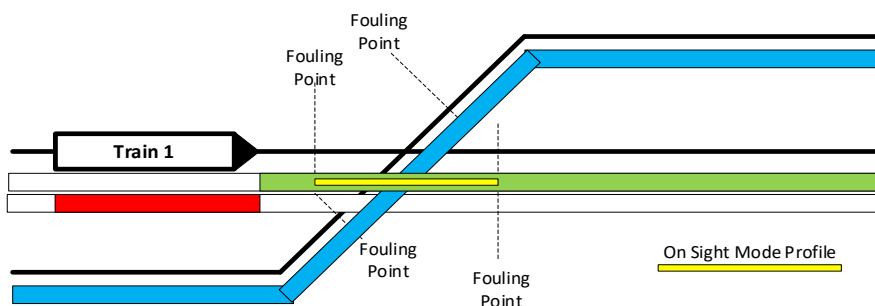


**Figure 63: L3 Margin before start of OS Mode Profile, Full Moving Block**



**Figure 64: L3 Margin before start of OS Mode Profile, Fixed Virtual Blocks**

If the Movement Authority crosses an Unknown Track Status Area at a crossing, this will also require an On Sight mode profile, as shown in Figure 65.



If an Unknown Track Status Area which results in an On-Sight mode profile is removed or reduced after the Movement Authority is issued, then it is project specific whether to update the authorisation, by removing or reducing the On-Sight mode profile.

**Figure 65: OS Mode Profile for crossing Unknown Track Status Area**

Operational Rules: OPE-OS-3; OPE-SH-3

Engineering Rules: ENG-Generic-5

REQ-MA-4	Optional	[X2R3 D4.2: REQ-MA-9]
----------	----------	-----------------------

The L3 Trackside shall be configurable to only issue Movement Authority updates relevant for operation of the railway.

Rationale:

Changes to the Movement Authority issued to a train cause recalculation of the speed supervision on board, and the results are displayed in the planning area. Frequent changes to the Movement Authority can therefore lead to distraction of the Driver. In accordance with 7.4.1.1 of ERA\_ERTMS\_015560, v3.60 [15560], if

the train is in Target Speed Monitoring for the EoA then a sound is played each time the Most Restrictive Displayed Target is updated. The configuration should allow the Infrastructure Manager to prevent changes in the extent/content of Movement Authorities until a period of time has elapsed or the change in the extent of the MA has exceeded the predefined threshold.

**Guidance:**

A threshold, based on time or distance, could be established such that only MA updates that exceed these limits are issued. The Infrastructure Manager should select the time and distance criteria for sending updates of MA. The distance should be selected to reflect the type of railway and would be shorter for a frequent service. Exceptions to the time and distance selected may be required to allow for short MA extensions to be sent to allow a train to complete a mission.

In implementing such limits on the MA update, it will be important to bear in mind the potential impact this may have on ATO operation (if fitted). Limiting the MA update may result in degrading the service due to suboptimal speed curves being followed. Careful analysis therefore needs to take place to ensure the impact is minimised. An alternative, that would require a change to the current ETCS baseline [BL3 R2], would be to decouple the update of the MA from the alerts that the Driver receives.

Operational Rules: None

Engineering Rules: ENG-Generic-1

---

REQ-MA-5	Mandatory	[X2R3 D4.2: REQ-MA-10]
----------	-----------	------------------------

---

The L3 Trackside shall report the Movement Authorities issued to trains to the Traffic Management System.

**Rationale:**

This is so that the Traffic Management System has information on the Movement Authorities issued.

**Guidance:**

The report to the TMS will include the complete information about Movement Authorities.

In a Full Moving Block system, Movement Authorities can end at any location on the railway.

Operational Rules: None

Engineering Rules: None

---

REQ-MA-6	Mandatory	[X2R3 D4.2: REQ-MA-11]
----------	-----------	------------------------

---

The L3 Trackside shall include Linking Information in Movement Authorities issued to trains.

**Rationale:**

Linking information improves the accuracy of position reports received from a train. Given the reliance on Train Position Reports in ETCS Level 3, it is critical that Linking Information is included.

Without the use of linking, there is a risk of a hazard arising from relocation. See Part 6 for more information.

**Guidance:**

None.

Operational Rules: None

Engineering Rules: ENG-Generic-8

---

REQ-MA-7	Mandatory	[X2R3 D4.2: REQ-MA-12]
----------	-----------	------------------------

---

If an area of track within a Reserved Status Area becomes Unknown after the Reserved Status Area has been established, but before the L3 Trackside has authorised a train to proceed into that area, the L3 Trackside shall:

- include an OS mode profile for the Unknown Track Status Area, OR
- restrict the authorisation to the start of the Unknown area, OR
- not send the authorisation to the train, OR
- request a decision from the Traffic Management System

**Rationale:**

An Unknown Track Status Area in a Reserved Area where a train is not yet authorised to run is not an immediate Hazard to the train. The train could be automatically authorised by L3 Trackside to sweep the Unknown Track Status Area or only after Dispatcher confirmation, depending on specific application requirements.

**Guidance:**

This requirement applies in the situation when a part of the track becomes Unknown after the Reserved Status Area has been established, but before a Movement Authority or SR Authorisation has been given.

Projects may decide that the L3 Trackside should take an automatic reaction as well as informing the Dispatcher, or only inform the Dispatcher and await their input before the L3 Trackside takes further action.

As this is before a train has been authorised, projects may also decide to remove or reduce the Reserved Status Area.

Operational Rules: OPE-OS-3

Engineering Rules: ENG-Generic-13



---



---

REQ-MA-8	Mandatory	[X2R3 D4.2: REQ-MA-12]
----------	-----------	------------------------

---

If an area of track within a Reserved Status Area becomes Occupied after the Reserved Status Area has been established, but before the L3 Trackside has authorised a train to proceed into that area, the L3 Trackside shall:

- restrict the authorisation to the start of the Occupied area, OR
- not send the authorisation to the train, OR
- request a decision from the Traffic Management System

Rationale:

An Occupied Track Status Area in a Reserved Area where a train is not yet authorised to run is not an immediate Hazard to the train.

Guidance:

This requirement applies in the situation when a part of the track becomes Occupied after the Reserved Status Area has been established, but before a Movement Authority or SR Authorisation has been given.

Projects may decide that the L3 Trackside should take an automatic reaction as well as informing the Dispatcher, or only inform the Dispatcher and await their input before the L3 Trackside takes further action.

As this is before a train has been authorised, projects may also decide to remove or reduce the Reserved Status Area.

Operational Rules: OPE-OS-3  
 Engineering Rules: ENG-Generic-11

---



---

REQ-MA-9	Optional	[X2R3 D4.2: REQ-FirstMA-2]
----------	----------	----------------------------

---

The L3 Trackside shall, if configured, provide the first MA for a train even if there is no confirmation of integrity by TIMS.

Rationale:

This is to enable trains without integrity confirmed by TIMS to still be moved under the supervision of ETCS.

Guidance:

The Infrastructure Manager may wish to configure the L3 Trackside such that the Traffic Management System must first approve giving the Movement Authority, having been notified of the train requesting a Movement Authority without confirmation of Train Integrity by TIMS.

Approval from the Traffic Management System for giving a Movement Authority may also be required if the Train Integrity is confirmed by the Driver, rather than by TIMS.

This requirement applies both in the situation of a train performing Start of Mission, or a train approaching the L3 Area in a Transition scenario.

Operational Rules: OPE-SoM-2

Engineering Rules: ENG-Generic-9; ENG-LossTI-2; ENG-LossTI-3

## 3.8 EoA Exclusion Area

### 3.8.1 Introduction

There may be areas of the railway where it is desirable that trains are not stopped by the authorisations from the L3 Trackside.

For example, consider:

- Powerless sections
- Level crossings
- Some tunnels or viaducts
- Points

A train could be given an authorisation such that all or part of the train may stop where trains should not be stopped. Thus a mechanism is required to ensure that an authorisation is not permitted to extend into an area where trains are not to be stopped.

This is called an “End of Authority (EoA) Exclusion Area”. When an EoA Exclusion Area is defined, the Level 3 Trackside will ensure that a train is able to completely leave the EoA Exclusion Area before giving or extending an authorisation beyond the EoA Exclusion Area. This must consider the length of the train, to ensure its rear end does not infringe the EoA Exclusion Area.

Two different types of EoA Exclusion Area are foreseen:

- Permanent EoA Exclusion Areas: where there is a predefined area in the track where it is desirable that trains are not stopped.
- Temporary EoA Exclusion Areas: these areas can be either predefined areas that can be activated or deactivated or created dynamically.

Note that EoA Exclusion Areas are a separate concept to Non Stopping Areas as already defined in the ETCS specifications (SUBSET 026 3.12.1.3 [BL3 R2]). Non Stopping Areas are a type of track condition and, once transmitted to the ETCS On-Board, are handled by the train. By contrast, an EoA Exclusion Area is a L3 Trackside concept and the train will not be aware of it being imposed.

It may be beneficial to define concurrent Non Stopping Areas so that the ETCS On-Board can display the Non-Stopping areas to the Driver. The EoA Exclusion Area is then used by the L3 Trackside to ensure that any authorisation issued permits the train to proceed beyond the area, and the Non-Stopping area is used by the On-Board on the display to the Driver.

### 3.8.2 Requirements

---



---

REQ-EoAExclusionArea-1	Mandatory	[X2R3 D4.2: REQ-EoAExclusionArea-1]
------------------------	-----------	-------------------------------------

---



---

The L3 Trackside shall be configurable with permanent EoA Exclusion Areas.

**Rationale:**

This is to avoid blocking points or level crossings with a train at standstill, preventing electric trains from stopping at powerless sections and any other operational issues resulting from stopping the train in certain areas of the track.

**Guidance:**

EoA Exclusion Areas need to be configured depending on the railway. In addition, EoA Exclusion Areas could impact the performance of the line by over impeding the issuing or extension of authorisations and hence, at its extreme, impacting the service headway. Therefore, detailed analysis is required when configuring these areas.

Operational Rules: None

Engineering Rules: ENG-Generic-2

---



---

REQ-EoAExclusionArea-2	Mandatory	[X2R3 D4.2: REQ-EoAExclusionArea-1]
------------------------	-----------	-------------------------------------

---



---

The L3 Trackside shall be able to activate and deactivate Temporary EoA Exclusion Areas.

**Rationale:**

If Temporary EoA Exclusion Areas are configured, they need the possibility to be activated and deactivated.

Additionally, these areas might be dynamically created for example by the TMS on request from Dispatcher and sent to the L3 Trackside to be activated and deactivated.

**Guidance:**

It is project specific how the Temporary EoA Exclusion Areas are configured and how to create a Dynamic EoA Exclusion Area.

Dynamic EoA Exclusion Areas could be established for temporary issues, for example where there is a damaged catenary which has had a temporary repair.

Operational Rules: None

Engineering Rules: ENG-Generic-2

---



---

REQ-EoAExclusionArea-3	Mandatory	[X2R3 D4.2: REQ-EoAExclusionArea-1]
------------------------	-----------	-------------------------------------

---



---

The L3 Trackside shall perform specific checks before activating or deactivating a Temporary EoA Exclusion Area.

Rationale:

This is to ensure a Temporary EoA Exclusion Area is only activated when it is safe to do so, or when the operational impact allows the activation.

Guidance:

Possible checks (project specific) may include:

- that there are no trains within the Temporary EoA Exclusion Area.
- the catenary repair is finished and power supply is recovered in the Temporary EoA Exclusion Area

Operational Rules: None

Engineering Rules: None

REQ-EoAExclusionArea-4	Mandatory	[X2R3 D4.2: REQ-EoAExclusionArea-2]
------------------------	-----------	-------------------------------------

For a train on the approach to an EoA Exclusion Area, the L3 Trackside shall only issue an MA to pass this area such that the train can proceed beyond the EoA Exclusion Area, taking into account the length of the train and the defined L3 Margin.

Rationale:

This is to avoid the train having an authorisation to stop with any part of the train in an EoA Exclusion Area.

Guidance:

Figure 66 illustrates an example of an EoA Exclusion Area in operation:

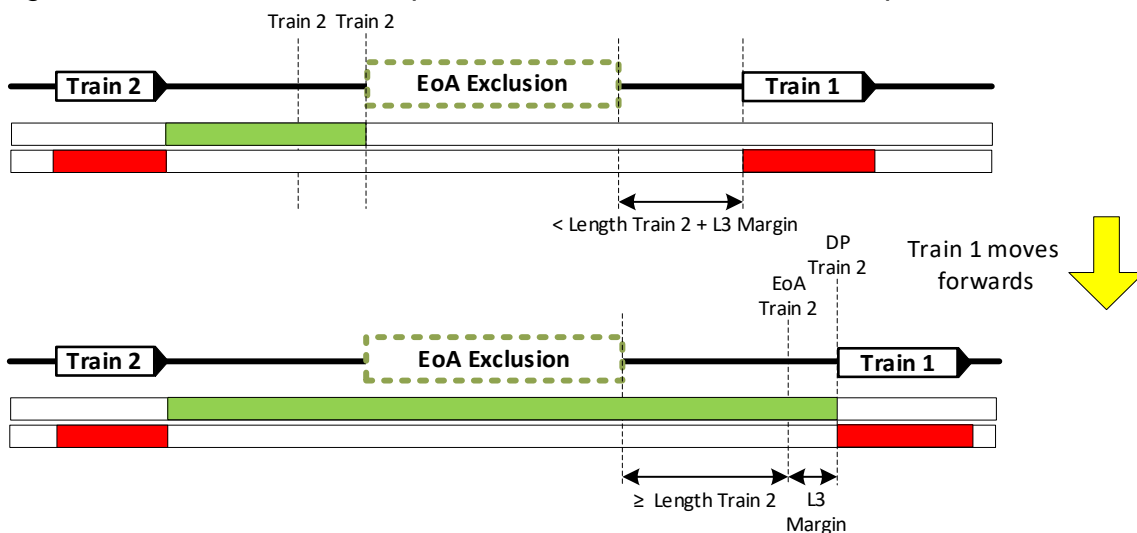


Figure 66: Example of an EoA Exclusion Area

It may be necessary to consider the Confidence Interval of trains passing through an EoA Exclusion Area. For static EoA Exclusion Areas, this can be addressed by engineering, for example by placing Balises near to the EoA Exclusion Areas, to reduce the Confidence Interval. For dynamic EoA Exclusion Areas, it may be necessary to consider additional margin.

Operational Rules: None

Engineering Rules: None

## 3.9 Start of Mission

### 3.9.1 Introduction

The Start of Mission for a train in the L3 Area is similar to the procedure for a L2 area. However, there are differences due to trains only being detected when they send position reports.

The L3 Trackside must be able to manage trains that are reporting Unknown or Invalid position during the Start of Mission. This could occur if the train has been in No Power mode, due to Cold Movement, or if the train does not have a valid Balise group to report as reference. The efficiency of Start of Mission of a train which has entered No Power mode within the area of control can be increased by using Cold Movement Detection.

### 3.9.2 Requirements

REQ-SoM-1	Mandatory	[X2R3 D4.2: REQ-StartTrain-1]
-----------	-----------	-------------------------------

The L3 Trackside shall always accept a train during Start of Mission.

Rationale:

Regardless of if a train has an invalid/unknown position, the L3 Trackside must accept and maintain a connection. For a train reporting a valid position, the L3 Trackside can determine whether or not this is within the Area of Control of the L3 Trackside. This requirement is to avoid hazards such as having a Ghost Train moving in the L3 area.

Guidance:

It could be configured to eventually disconnect the train after a timeout. Alternatively, the TMS could request the L3 Trackside to disconnect the communication if the train is not within its area of control.

Operational Rules: None

Engineering Rules: None

REQ-SoM-2	Mandatory	[X2R3 D4.2: REQ-StartTrain-2]
-----------	-----------	-------------------------------

The L3 Trackside shall alert the TMS of a train that it is unable to establish a Train Location for with the information in the Start of Mission position report.

Rationale:

A train reporting an invalid, unknown or ambiguous position may need to be located manually by the Dispatcher.

Guidance:

This can happen if the train is reporting:

- an invalid or unknown position, or a valid position from an NID\_BG not known to the L3 Trackside.

- a valid position from a known NID\_LRBG when the L3 Trackside is not able to unambiguously locate the train, e.g. there are points between the LRBG and the front of the train.

If the L3 Trackside is able to locate the train by some other means, then the TMS will not need to be notified.

Operational Rules: None

Engineering Rules: None

---

REQ-SoM-3	Mandatory	[X2R3 D4.2: REQ-StartTrain-12]
-----------	-----------	--------------------------------

---

The L3 Trackside shall maintain the communication session with a train for which it is unable to establish a Train Location from the information in the Start of Mission report, unless requested by the TMS to terminate the session with this train.

Rationale:

This is to avoid the potential hazard of having a Ghost Train moving in the L3 Area.

Guidance:

The Dispatcher may then either assign the train a position or conclude that this train is not in the L3 Trackside and request that the session is terminated.

Operational Rules: None

Engineering Rules: None

---

REQ-SoM-4	Mandatory	[X2R3 D4.2: REQ-StartTrain-3]
-----------	-----------	-------------------------------

---

The L3 Trackside shall create a Train Location from a train position received from the TMS, if this position lies within an existing Unknown Track Status Area.

Rationale:

This is to allow the TMS with the information provided by the Dispatcher to locate the train on the track when the train position is otherwise not available or ambiguous.

Guidance:

The position given by the TMS for the train should lie within an existing Unknown Track Status Area. If it does not, then either the dispatcher has made a mistake with the position entry, or there has been an undetected movement of the train.

The TMS will need to be able to provide the Dispatcher with facilities to enter a position of a train which has reported an invalid or unknown position, or a valid position which is ambiguous to the L3 Trackside. This could be done by assigning a position for the front or rear end of the train. The L3 Trackside will then check that this position is within an existing Unknown Track Status Area and alert the Dispatcher via TMS if it is not. The event of the train not being located inside an existing Unknown Track Status Area should be highly unlikely, due to the L3

Trackside mechanisms for managing degraded situations and the operational rules for managing the movement of non-communicating trains.

The L3 Trackside could use Stored Information for Unknown Track Status Areas and compare this with data received from the train to aid with locating it in the L3 Area. The details of this are project specific.

For a system with TTD, this may help the system to locate the train.

Operational Rules: OPE-SoM-3; OPE-SoM-4; OPE-SoM-5  
 Engineering Rules: None

---



---

REQ-SoM-5	Mandatory	[X2R3 D4.2: REQ-StartTrain-4]
-----------	-----------	-------------------------------

---

The L3 Trackside shall alert the Dispatcher via the TMS when creating a Train Location from a train position received from the TMS which is not within an existing Unknown Track Status Area.

Rationale:

If the position assigned for a train by the Dispatcher is not inside any Unknown Track Status Area, then either the dispatcher has made a mistake with the position entry, or there has been an undetected movement of the train.

Guidance:

In addition to alerting the TMS to the situation, the L3 Trackside may be designed to take additional actions.

The Dispatcher might then, following project specific operational rules, either create an Unknown Track Status Area to associate with the assigned Train Location, or assign a new Train Location to that train.

Operational Rules: None  
 Engineering Rules: None

---



---

REQ-SoM-6	Mandatory	[X2R3 D4.2: REQ-StartTrain-13]
-----------	-----------	--------------------------------

---

On request from the TMS, the L3 Trackside shall order the train to terminate the communication session.

Rationale:

It is beneficial to maintain the session with a train even if the train does not have a known position, as for the L3 Trackside this is the only means of being aware of the train. However, if a train is determined to be incorrectly connected to the L3 Trackside (e.g. it is confirmed to not be inside the Area of Control and there is not an ongoing Handover for that train) then the L3 Trackside needs the ability to disconnect and free the communication session for another train.

**Guidance:**

Projects may decide there are specific circumstances where the L3 Trackside can decide to disconnect a particular train, for example in Level Transition/Handover scenarios.

Operational Rules: None

Engineering Rules: None

---



---

REQ-SoM-7	Optional	[X2R3 D4.2: REQ-StartTrain-14]
-----------	----------	--------------------------------

---



---

The L3 Trackside shall, if configured, alert the TMS of a train which terminated its communication session without sending Validated Train Data to the L3 Trackside.

**Rationale:**

If a train disconnects without having sent Validated Train Data, then the L3 Trackside may be required to react by alerting the Dispatcher, as no L\_TRAIN has been received to establish the location for this train.

**Guidance:**

The Dispatcher, following non-harmonised rules, may need to contact the Driver to ensure e.g. where this train is, whether it was a Driver's mistake, etc.

Operational Rules: OPE-SoM-6

Engineering Rules: ENG-SoM-1

---



---

REQ-SoM-8	Optional	[X2R3 D4.2: REQ-StartTrain-15]
-----------	----------	--------------------------------

---



---

The L3 Trackside shall, if configured, alert the TMS about communicating trains for which the L3 Trackside has not received Validated Train Data after a defined timeout.

**Rationale:**

This is to enable an action that may be required when Validated Train Data has not been received from a communicating train.

**Guidance:**

The Dispatcher, following non-harmonised rules, may need to contact the Driver to ensure e.g. where this train is, whether it was a Driver's mistake, a train failure, etc.

Operational Rules: OPE-SoM-6

Engineering Rules: ENG-SoM-2



### 3.10 SR Movement

#### 3.10.1 Introduction

Staff Responsible (SR) mode is the primary means of moving non-communicating trains or communicating trains without a Train Location. It can also be used if, for some reason, an MA is not possible. Authorisation to move in SR mode must therefore follow a defined procedure which is out of the scope of this document.

The Use of Staff Responsible can be categorised into three scenarios:

**Train without connection to the L3 Trackside:** In this scenario, the Driver must use the Override function to enter SR mode, as it cannot be authorised by the L3 Trackside. The Dispatcher must be able to establish a location for the train from the Driver and create an Unknown Track Status Area to protect the train and its subsequent movement. No additional functionality is required from the L3 Trackside.

**Train has a connection to the L3 Trackside but cannot be located due to invalid or unknown position:** In this scenario, the Dispatcher must provide an estimated train position to the L3 Trackside and protect the path the train will take by establishing a Reserved Status Area or an Unknown Track Status Area. The L3 Trackside can then authorise the train for movement in SR with an SR distance and a list of Balises that can be passed, to the end of the established area. The objective of this operation is to permit the train to move such that it can establish a known position and thereby a Train Location.

**Train has a connection to the L3 Trackside and can be located, but it is not possible to issue an MA:** In this scenario, the Dispatcher must establish an Unknown Track Status Area for the train to move within, then the L3 Trackside can calculate the SR distance and a list of Balises that can be passed before authorising the train for movement in SR.

In the third scenario, there is the possibility that the L3 Trackside is still not able to authorise SR movement (due to an obstruction for example). In this case, the driver must still use the override functionality following operational procedures.

#### 3.10.2 Requirements

REQ-MovSR-1	Mandatory	[X2R3 D4.2: REQ-MovSR-1]
-------------	-----------	--------------------------

Following an MA Request from a train located in rear of an adjacent Unknown Track Status Area created by the TMS and not used for another authorisation, the L3 Trackside shall provide an SR Authorisation to this train with the distance to run no longer than the Unknown Track Status Area.

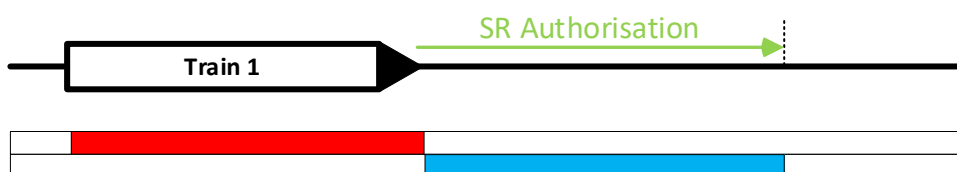


Figure 67: SR Authorisation up to the end of an Unknown area

**Rationale:**

This is to enable a train to pass an area which cannot be reserved, for example if points are not controlled.

**Guidance:**

This requirement applies both to trains with a known position and to trains with a position assigned by TMS/Dispatcher. However, it should be noted that the location for a train that moves from a position given by the Dispatcher will not be updated until the L3 Trackside receives a position report with a known LRBG.

The distance permitted to move in an SR Authorisation is based on the extent of an area in front of the train which is used to protect this movement.

An Unknown Track Status Area cannot be used for another authorisation if the L3 Trackside has already provided an SR Authorisation for another train to enter the Unknown Track Status Area, or if there is a Reserved Status Area which enters the Unknown Track Status Area.

Projects may decide on providing a shorter distance than that of the area in front of a train if the SR Authorisation is intended for the train to read a balise group and get a known LRBG. In that case, it is recommended to give a distance such that the train can pass at least one balise group, or two if the first is a single balise group.

Projects may also decide on a longer distance than the Unknown Track Status Area in front of a train, if this is short and followed by a Reserved Area intended for the same train.

Operational Rules: None

Engineering Rules: ENG-MovSR-1

---



---

**REQ-MovSR-2**
**Mandatory**
**[X2R3 D4.2: REQ-MovSR-2]**


---



---

For a train with a Train Location, the L3 Trackside shall maintain the previous CRE of a train in SR mode from when the train reports in SR until the train transitions out of SR to FS/OS mode and reports with Train Integrity confirmed.

**Rationale:**

When the train is in SR mode, Balise Linking information is not available. Therefore, there is a risk that the CRE is updated incorrectly due to the train relocation function. As a result, the CRE is not updated by the L3 Trackside until the train transitions to FS or OS mode.

**Guidance:**

For trains which have not confirmed Train Integrity, there will be no CRE. In this case the Track Status will be Unknown, and the rear boundary of the Unknown Track Status Area should be maintained, as described by the functionality in section 3.16, Loss of Train Integrity.

Operational Rules: None  
 Engineering Rules: None

---



---

REQ-MovSR-3	Mandatory	[X2R3 D4.2: REQ-MovSR-3]
-------------	-----------	--------------------------

---

Following an MA Request from a train with a position given by the Dispatcher in rear of an adjacent Reserved Status Area, the L3 Trackside shall provide an SR Authorisation to this train with the distance to run within the Reserved Status Area.

**Rationale:**

This is for moving a train in SR mode to read a balise group and establish a known position.

**Guidance:**

The distance permitted to move in an SR Authorisation is based on the extent of an area in front of the train which is used to protect this movement.

Projects may decide on providing a shorter distance than that of the Reserved Area in front of a train if the SR Authorisation is intended for the train to read a balise group and get a known LRBG. In that case, it is recommended to give a distance such that the train can pass at least one balise group, or two if the first is a single balise group.

Operational Rules: None  
 Engineering Rules: ENG-MovSR-1

---



---

REQ-MovSR-4	Mandatory	[X2R3 D4.2: REQ-MovSR-4]
-------------	-----------	--------------------------

---

When giving an SR Authorisation to a train, the L3 Trackside shall include a list of balise groups the train is allowed to pass in the given authorisation.

**Rationale:**

Providing a list of balises together with an SR Authorisation reduces the potential risk that a train moves undetected in a track where it is not expected to be, especially when there is no TTD.

**Guidance:**

The number of balise groups provided to be included in this list is project specific but should include the balise groups expected to be passed when moving in SR mode, if any.

Operational Rules: None  
 Engineering Rules: None

## 3.11 Loss of Communication

### 3.11.1 Introduction

Following loss of communication, the status of an area where the train has been authorised to move must be considered Unknown, as the train may be anywhere between the last Confirmed Rear End of the train and the end of its most recent authorisation.

If the communication session is restored, then the Unknown Track Status Area associated with the train due to the loss of communication is updated based on position reports, after checks that the new communications are for the same train, same length – as explained in section 3.12.

If the communication session is not restored, or communication is restored but the train is not recognised as the same train, then the Track Status will remain Unknown, and it will need to be cleared by some other method.

### 3.11.2 Requirements

REQ-LossComms-1	Optional	[X2R3 D4.2: REQ-LossComms-1]
-----------------	----------	------------------------------

The L3 Trackside shall, if configured, for each train with which it has an active communication session supervise a defined timeout (a Mute Timer) after which the communication with this train is considered lost.

Rationale:

This is to enable the L3 Trackside to react faster to the potential loss of communication with an ETCS On-board than the timeout in the ETCS specifications. The ETCS specification timer of 5 minutes might be considered too long for some ETCS Level 3 systems.

Guidance:

This Requirement is mandatory if the Mute timer is used.

This is an optional functionality to be defined at application level based on the needs of the system. The value of the Mute timer will be longer than the variable T\_NVCONTACT and shorter than the communication session expiry, as defined in [SS026].

Operational Rules: None

Engineering Rules: ENG-LossComms-1

REQ-LossComms-2	Optional	[X2R3 D4.2: REQ-LossComms-2]
-----------------	----------	------------------------------

When receiving a message from a train and if the use of a Mute Timer is configured, the L3 Trackside shall (re-)start the Mute Timer for this train.

Rationale:

This is for the L3 Trackside to be able to react if a message from the train is not received within a configured time.

**Guidance:**

This Requirement is mandatory if the Mute timer is used.

If a Mute Timer is configured it is only active when there is a communication session with the train.

Operational Rules: None

Engineering Rules: ENG-LossComms-1

---

REQ-LossComms-3	Optional	[X2R3 D4.2: REQ-LossComms-4]
-----------------	----------	------------------------------

---

When the Mute Timer expires for a train which has not entered an announced Radio Hole, and which was not reporting in RV mode, the L3 Trackside shall change the Track Status Area associated with the train to Unknown and extend this Area until the end of the Reserved Status Area allocated to this train or the end of the MA, whichever is shorter.

**Rationale:**

This is the area where the non-communicating train could be located, and as such needs to be protected.

**Guidance:**

This Requirement is mandatory if the Mute timer is used.

If the extent of the MA sent to the train is less than the full Reserved Status Area, then the extension of the Track Status Area may only be to the end of the MA sent to the train.

The criteria for establishing whether a train has entered a Radio Hole are project specific and could include the train having received radio hole track condition information from the L3 Trackside.

Once a train is reporting in RV mode, it is not able to move forwards without performing EoM, Start of Mission, so it is not necessary to extend the Unknown to the end of the Reserved Status Area or MA.

The L3 Trackside will maintain the communication session with ETCS On-board as active even when the Mute timer has expired until the maximum time to maintain a communication session as specified in SUBSET-026 [BL3 R2] has elapsed.

Operational Rules: None

Engineering Rules: None

---

---

REQ-LossComms-4	Mandatory	[X2R3 D4.2: REQ-LossComms-5]
-----------------	-----------	------------------------------

---

---

If the Mute Timer is not considered for use on a particular application, the L3 Trackside shall react when the session timer expires by setting the Track Status Area associated with the train to Unknown and extend this Area until the end of the Reserved Status Area allocated to this train or the end of the MA, whichever is shorter, except if the train was reporting in RV mode.

**Rationale:**

This is so that, even for applications not utilising the Mute timer functionality, the Trackside is protected when communications with a train expire according to the existing session expiry timer in the ETCS specifications [BL3 R2].

**Guidance:**

Whether or not to use the Mute Timer will depend on whether it is required to detect loss of communication before expiry of the session timer. This in turn will depend on traffic density and the typical speed of trains.

Once a train is reporting in RV mode, it is not able to move forwards without performing EoM and Start of Mission, so it is not necessary to extend the Unknown to the end of the Reserved Status Area.

For a system using TTD, there may be clear TTDs ahead of the train within the Reserved Status Area. In this case, the Unknown Track Status Area can be extended to the least distant position of the next TTD that is clear. This is equivalent to extending the Unknown Track Status Area up to the end of the MA, in accordance with this requirement, and then clearing those parts of the extended Unknown Track Status Area in accordance with TTD requirements.

Operational Rules: None

Engineering Rules: None

## 3.12 Recovery management after loss of communication

### 3.12.1 Introduction

Fast recovery of the railway state after a train has lost communication is key to ensuring availability of the ETCS Level 3 system. After a train reconnects following loss of communication, the Unknown Track Status Area caused by the loss of communications is updated based on position reports to enable continuation of normal railway operation. The use of stored information can enable track with Track Status previously considered Unknown to be updated from the received Train Position Reports.

The usability of stored information depends upon the train reconnecting being recognised as identical to the one that originally lost communications.

In recovery from a loss of communication two scenarios can occur:

- reconnection within the same session
- reconnection after session expiry.

Reconnection after session expiry is in principle the same as a train performing Start of Mission (described in section 3.9, Start of Mission). However, the L3 Trackside considers this scenario differently due to the following:

- The Unknown Track Status Area could be large, as it extends from the previous CRE to the end of its given authorisation.
- The session expired rather than being terminated.

If the train reconnecting cannot be confirmed as the same train as the one that lost communications, for example due to a difference in the train data, then the Unknown Track Status Area must be recovered using different procedures, such as sweeping train in On Sight.

### 3.12.2 Requirements

---

REQ-RecoveryMgmt-1	Mandatory	[X2R3 D4.2: REQ-RecoveryMgmt-1]
--------------------	-----------	---------------------------------

---

The L3 Trackside shall consider a train which starts communicating with the L3 Trackside within the same communications session as previously used for the train as the same train, so long as no change in train data has occurred.

#### Rationale:

The Track Status can only be recovered in an area when it is the same train that lost communications which reconnects with the L3 Trackside in that area

#### Guidance:

The L3 Trackside is certain that this is the same train, as it is using the same communication session. This will allow the Track Status to be updated.

This situation will either occur after expiry of the mute timer in REQ-LossComms-1, but before expiry of the communications session, or when a train exits a Radio Hole.

The changes in Track Status following recovery of communications are provided in requirement REQ-RecoveryMgmt-3 below.

It can be assumed that it is the same train if the train continues to report Train Integrity, because Change Request 940 [CR940] ensures that Train Integrity reporting can only be done if the train data has been acknowledged. If the train is still reporting integrity, and train data has not been revalidated, then no change of train length has occurred.

Operational Rules:       None

Engineering Rules:       None

---

REQ-RecoveryMgmt-2	Mandatory	[X2R3 D4.2: REQ-RecoveryMgmt-2]
--------------------	-----------	---------------------------------

---

The L3 Trackside shall consider a train reconnecting with a new communications session as the same train after passing the following checks:

- the train has the same ID (NID\_ENGINE), AND
- the train has the same length (L\_TRAIN)

**Rationale:**

If the L3 Trackside is certain that this is the same train, the Track Status of the associated area can be updated, and the train be authorised again.

**Guidance:**

This situation will occur after expiry of the session timer, if the ETCS On-board closes the connection and redials the L3 Trackside, during an initialisation of the L3 Trackside, or when a train exits a Radio Hole.

This situation is similar to Start of Mission, i.e. that the train is associated with an Unknown Track Status Area in the track.

The changes in Track Status following recovery of communications are provided in requirement REQ-RecoveryMgmt-3 below.

Operational Rules: None

Engineering Rules: None

---

REQ-RecoveryMgmt-3	Mandatory	[X2R3 D4.2: REQ-RecoveryMgmt-3]
--------------------	-----------	---------------------------------

---

If the L3 Trackside determines that the same train has reconnected and confirmed Integrity, the L3 Trackside shall update the Unknown Track Status Area associated with this train, resulting from the loss of communication, to an Occupied Track Status Area with an extent corresponding to the new Train Location.

**Rationale:**

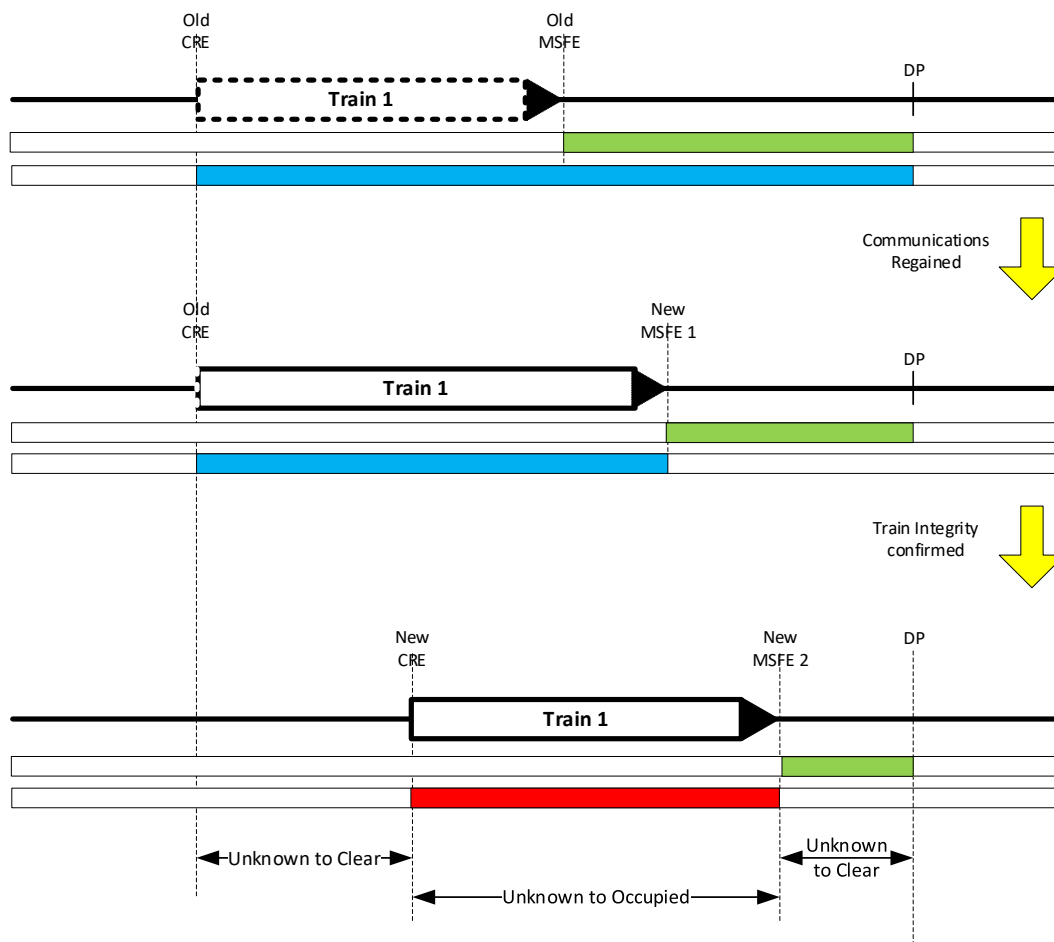
If the L3 Trackside is certain that this is the same train, after loss of communication or Trackside Initialisation, the Train Location can be determined based on train position information and the rest of the affected Unknown Track Status Area can be cleared.

**Guidance:**

The criteria for recognising a train which has reconnected as the same train is defined in REQ-RecoveryMgmt-2.



When the Unknown Track Status Area resulting from the loss of communication is updated to an Occupied Track Status Area corresponding to the new Train Location, then that part of the Unknown Track Status Area not within the Occupied Track Status Area will become Clear. Figure 68 highlights the areas of track that will transition Unknown to Clear, and Unknown to Occupied:



**Figure 68: Unknown to Clear and Occupied following reconnection of communications**

If, before the loss of communication, there was part of a Sweepable Unknown Track Status Area between the previous CRE and the new mSFE, that would be removed.

If, before the loss of communication, there was part of a Sweepable Unknown Track Status Area in front of the new mSFE, that would remain.

Operational Rules: None  
 Engineering Rules: None

## 3.13 Radio Hole

### 3.13.1 Introduction

Due to the reliance on radio communication, the L3 Trackside must manage the issue of Radio Holes in a safe manner. The lack of TTD requires additional system functionality over that defined at ETCS L2.

The L3 Trackside can handle two types of Radio Hole:

- a) Permanent: present in the communications system since the L3 Trackside was commissioned
- b) Temporary: occur after the L3 Trackside is commissioned. These may be transient or become permanent.

Temporary Radio Holes are predefined in the L3 Trackside when the system is commissioned, according to the location of radio transmitters and their coverage of the railway. They are then activated or deactivated by the TMS when a failure of the radio network infrastructure occurs.

To manage an Active Radio Hole, the L3 Trackside has two key functionalities:

- a) An EoA Exclusion Area will be defined such that a train cannot obtain an EoA within the Radio Hole
- b) The L3 Trackside will store information regarding when a train enters a Radio Hole, and alert the Traffic Management System if, after a pre-set timer has expired, the train has not reported having exited the area.

The concept of Radio Holes is already present in the existing ETCS specifications as a type of track condition transmitted to the ETCS On-board from the Trackside. It is expected that this functionality is implemented in parallel to the L3 Trackside functionality described here.

### 3.13.2 Requirements

REQ-RadioHole-1	Optional	[X2R3 D4.2: REQ-RadioHole-1]
-----------------	----------	------------------------------

On request from the TMS, the L3 Trackside shall activate or deactivate predefined Temporary Radio Holes.

Rationale:

Since this is a temporary issue, the trigger to activate the Temporary Radio Hole has to come from the Traffic Management System.

Guidance:

This is an optional requirement.

Temporary Radio Holes are predefined in the L3 Trackside, ready for activation by the TMS if required.

Operational Rules: OPE-LossComms-2; OPE-LossComms-3

Engineering Rules: ENG-RadioHole-1

---



---

REQ-RadioHole-2	Mandatory	[X2R3 D4.2: REQ-RadioHole-2]
-----------------	-----------	------------------------------

---



---

The L3 Trackside shall establish an EoA Exclusion Area for each Active Radio Hole.

**Rationale:**

To avoid a train reaching an End of Authority in a Radio Hole and not being able to proceed (except in SR).

**Guidance:**

This Requirement is only Mandatory if there are Radio Holes in the Area of Control.

Operational Rules: None

Engineering Rules: None

---



---

REQ-RadioHole-3	Mandatory	[X2R3 D4.2: REQ-RadioHole-3]
-----------------	-----------	------------------------------

---



---

The L3 Trackside shall remove the EoA Exclusion Area created for a Temporary Radio Hole if the Radio Hole is deactivated.

**Rationale:**

To return to normal operation once the Radio Hole does no longer exists.

**Guidance:**

This Requirement is only Mandatory if there are Radio Holes in the Area of Control.

Operational Rules: None

Engineering Rules: None

---



---

REQ-RadioHole-4	Mandatory	[X2R3 D4.2: REQ-RadioHole-4]
-----------------	-----------	------------------------------

---



---

The L3 Trackside shall start the Radio Hole timer when a train enters a Radio Hole.

**Rationale:**

This is to monitor a train that has entered a Radio Hole and alert the Dispatcher if the train does not emerge from it before the Radio Hole timer expires.

**Guidance:**

This Requirement is only Mandatory if there are Radio Holes in the Area of Control.

The criteria for determining when a train has entered a Radio Hole are project specific and could include (not exhaustive):

- The reception of a position report with the max safe front end having passed the start location of the Radio Hole.
- Mute timer expiry following sending radio hole track condition information to the train.

Projects may decide to re-start the Radio Hole timer if the train reports again and its Min Safe Front End has not yet entered the Radio Hole.

Operational Rules: None

Engineering Rules: ENG-RadioHole-2

---



---

REQ-RadioHole-5	Mandatory	[X2R3 D4.2: REQ-RadioHole-5]
-----------------	-----------	------------------------------

---



---

While the L3 Trackside considers that a train is inside a Radio Hole, the L3 Trackside shall stop supervising the following timers:

- Mute timer Section 3.11
- Integrity Wait Timer Section 3.16
- ETCS session timer Section 3.11

Rationale:

When a train is in a Radio Hole there is no point waiting for messages from it.

Guidance:

This Requirement is only Mandatory if there are Radio Holes in the Area of Control.

When the L3 Trackside stops supervising a timer, no reaction is taken if the timer subsequently expires.

If any message is received while the train is in a Radio Hole, projects may decide to use it i.e., update Train Location but not for re-starting the timers mentioned in this requirement.

Operational Rules: None

Engineering Rules: None

---



---

REQ-RadioHole-6	Mandatory	[X2R3 D4.2: REQ-RadioHole-6]
-----------------	-----------	------------------------------

---



---

Upon expiry of the Radio Hole timer, the L3 Trackside shall treat the train the same as for loss of communication.

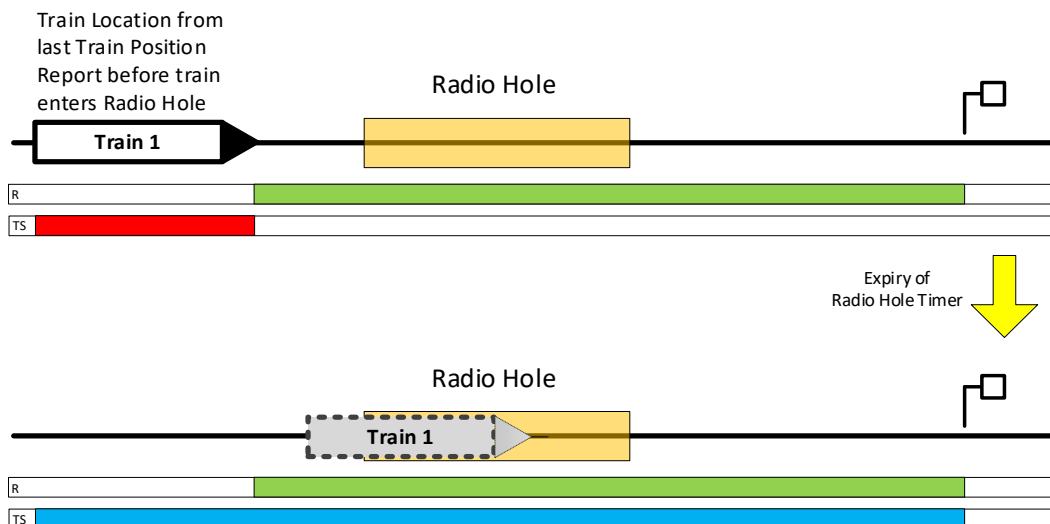
Rationale:

This is because there could be a train unable to contact the L3 Trackside to proceed with its movement: either because it has suffered a failure within the Radio Hole, or it has failed to reconnect upon exiting the Radio Hole.

Guidance:

This Requirement is only Mandatory if there are Radio Holes in the Area of Control.

Figure 69 below shows the creation of the Unknown Track Status Area after expiry of a Radio Hole Timer:



**Figure 69: Unknown Area after expiry of Radio Hole Timer**

Operational Rules: None

Engineering Rules: ENG-RadioHole-2

REQ-RadioHole-7	Mandatory	[X2R3 D4.2: REQ-RadioHole-7]
-----------------	-----------	------------------------------

Upon expiry of the Radio Hole timer, the L3 Trackside shall inform the TMS that a train has not emerged from a Radio Hole.

Rationale:

This is because there could be a train unable to contact the L3 Trackside to proceed with its movement: either because it has suffered a failure within the Radio Hole, or it has failed to reconnect upon exiting the Radio Hole.

Guidance:

This Requirement is only Mandatory if there are Radio Holes in the Area of Control.

Alternatively, operational procedures can be defined based on an application specific solution or use TTD at the borders of the Permanent Radio Hole area.

Operational Rules: OPE-LossComms-4

Engineering Rules: ENG-RadioHole-2

REQ-RadioHole-8	Mandatory	[X2R3 D4.2: REQ-RadioHole-8]
-----------------	-----------	------------------------------

The L3 Trackside shall stop the Radio Hole timer when a train has left a Radio Hole.

Rationale:

This is to avoid a reaction by the L3 Trackside when the train has managed to exit the Radio Hole.

**Guidance:**

This Requirement is only Mandatory if there are Radio Holes in the Area of Control.

The criteria for determining when a train has left a Radio Hole are project specific and could include the detection of the Max or Min Safe Front End of the train at or beyond the boundary of the Radio Hole.

Operational Rules: None

Engineering Rules: None

## 3.14 Reversing

### 3.14.1 Introduction

This section covers movements in RV mode.

In Level 3, Movement Authorities can be issued up to the rear of a preceding train, therefore Reversing needs additional consideration. When a train has been given Reversing Area information, the L3 Trackside must ensure that no conflict can arise in the area where the train may reverse, i.e. to avoid it being authorised for use by another train. How to do this is left to the projects that need the possibility to reverse, but some suggestions are given as guidance for REQ-Rev-1.

The requirements in this section are only Mandatory for projects where Reversing is used.

### 3.14.2 Requirements

REQ-Rev-1	Mandatory	[X2R3 D4.2: REQ-Rev-1]
-----------	-----------	------------------------

When a train has been given Reversing Area information, the L3 Trackside shall prevent authorising other trains into the area where this train may reverse.

**Rationale:**

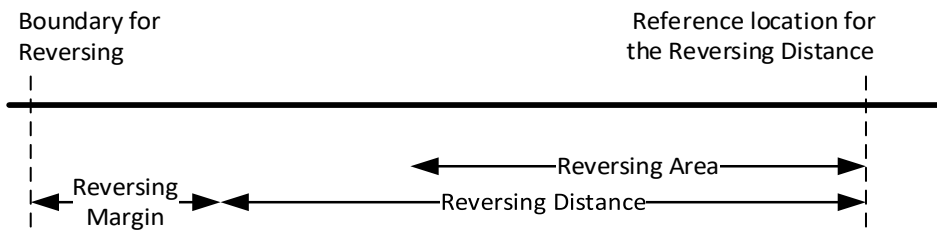
This is to avoid the risk for collision in an area where a train has been given the possibility to reverse.

**Guidance:**

The area for which other authorisations must be prevented is from where a train may start to reverse to the location where the rear of the train may stop after reversing the permitted distance, plus a margin, referred to as the “Boundary for Reversing”. Projects that need the possibility to reverse must themselves decide on the mechanism for protecting a train that may reverse. One possibility would be to activate an EoA Exclusion Area for the area in which a train may reverse. For projects using Fixed Virtual Blocks, it would be enough to engineer that area as a single virtual block section, as this will prevent normal authorisations into that section until it is free.

Figure 70 illustrates the extent of the area to be protected from other movements, including the Reversing Area, Reversing Distance and an additional Reversing

Margin. The Reversing Margin should consider the length of the train permitted to reverse and an estimated distance for the train to brake to stop if overpassing the permitted reversing distance. Projects may decide to engineer the location of the Boundary for Reversing as a fixed location considering a worst-case scenario, or multiple fixed locations depending on train types, or calculate it dynamically considering the characteristics of the train given permission to reverse (actual train length, braking capacity, etc.).



**Figure 70: Area to protect for a reversing train**

The L3 Trackside must prevent other authorisations into this area from when the CRE of the train permitted to reverse is beyond the Boundary for Reversing and until this train is no longer permitted to reverse in this area, e.g. either until the train's front end has passed the Reversing Area from which it may start to reverse or until the train has performed EoM. The permission to reverse can also be replaced with a new Reversing Area for another location or deleted if the Reversing Area is no longer part of the current authorisation.

Note: the ETCS Specifications [BL3 R2] allows for updating the reversing area information given to a train, e.g. the Reversing Distance. However, if this would mean that the Boundary for Reversing is moved further backwards, then the additional area must be free and protected from other movements.

Operational Rules: None

Engineering Rules: ENG-Rev-1

REQ-Rev-2	Mandatory	[New]
-----------	-----------	-------

When receiving a position report from a train in RV mode, the L3 Trackside shall remove any Reserved Status Area remaining for this train.

Rationale:

This is to release that part of the track for other train movements as the reversing train is no longer able to use it.

Guidance:

None

Operational Rules: None

Engineering Rules: None

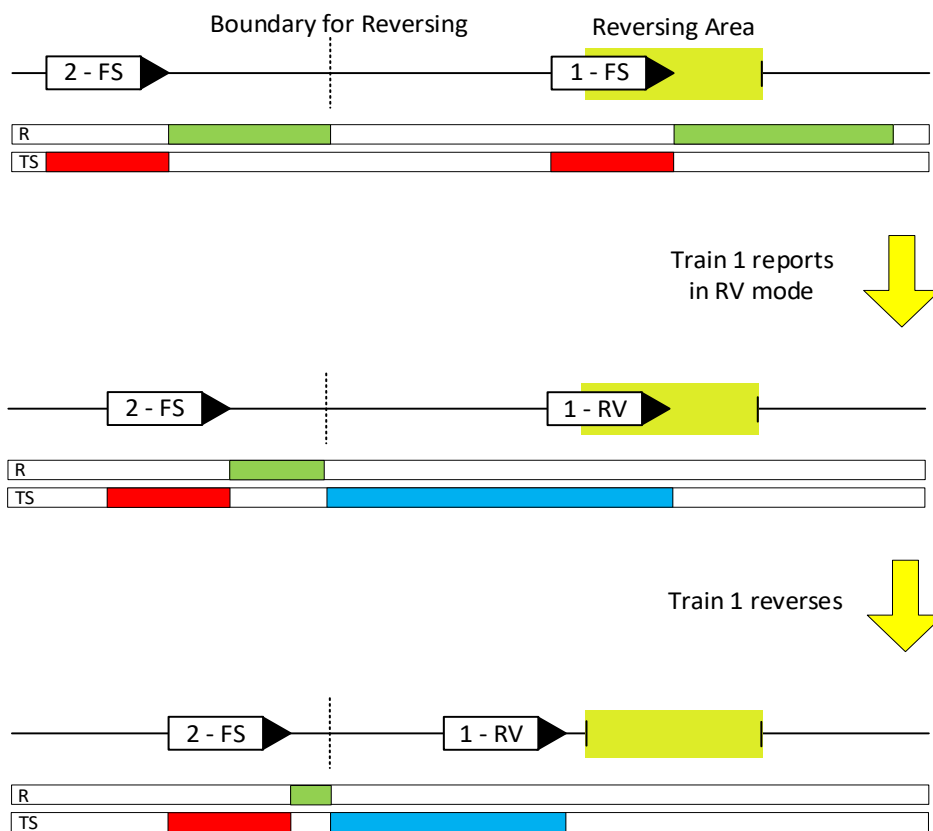
When receiving a position report from a train in RV mode, the L3 Trackside shall change the Track Status for the area associated with this train to Unknown and Non-Sweepable, and extend that area to the Boundary for Reversing.

Rationale:

A train in RV mode will no longer report integrity confirmation, nor will linking information be available. As such, its exact position will not be known.

Guidance:

Once a train has reported in RV mode, its position can no longer be accurately located. As such, the L3 Trackside should consider the possible area the train may be in while reversing as Unknown. However, the train continues to send position reports in RV mode, so the reported Max Safe Front End can be used to update the Track Status Area associated with the train (see REQ-TrainLoc-7), as seen in the Figure 71 below.



**Figure 71: Update of the Track Status Area following a train reporting in RV mode**

The Unknown Track Status Area for Train 1 is reduced as the train moves backwards in RV mode, sending Train Position Reports.

Operational Rules: None

Engineering Rules: None



When the Mute Timer expires for a train which has been given Reversing Area Information, the L3 Trackside shall extend the Track Status Area associated with the train to the Boundary for Reversing if the L3 Trackside:

- has not received that the train is in RV mode, AND
- has determined the CRE beyond the Boundary for Reversing, AND
- has not established the Estimated Front End beyond the end of the Reversing Area

Rationale:

If communications are lost with a train that has been given Reversing Area Information, the train may perform reversing with the L3 Trackside unaware of this. As such, the L3 Trackside needs to protect all of the area where the train could reverse. This requirement only handles what is exclusive to reversing, i.e. the rear end of the Track Status Area associated with the train, while the front end and the status of the area is handled by REQ-LossComms-3.

Guidance:

Figure 72 gives an overview of the reaction taken by the L3 Trackside when this situation occurs.

The Unknown Track Status Area extends from the Boundary for Reversing to the end of the Reserved Status Area. This is achieved through the application of this requirement and REQ-LossComms-3.

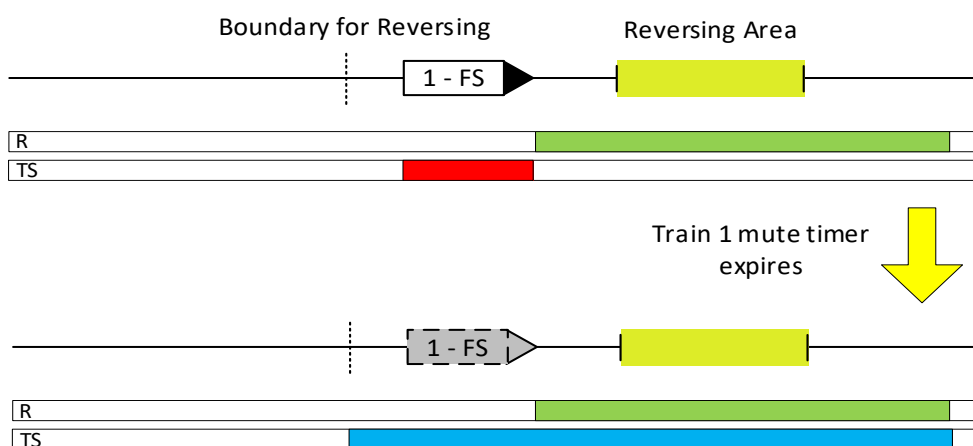


Figure 72: Mute Timer Expiry for a train that has received Reversing Area Information.

Operational Rules: None

Engineering Rules: None

## 3.15 End of Mission

### 3.15.1 Introduction

The Track Status Area associated with a Train which performs EoM needs to be updated and changed to Unknown if this was not already the Status, to protect the area where the train can be. The Reserved Area has to be released so that other trains can use that part of the railway.

The requirement about changing the Track Status Area to Unknown is in section 3.2.

### 3.15.2 Requirements

REQ-EoM-1	Mandatory	[X2R3 D4.2: REQ-EoM-2]
-----------	-----------	------------------------

When receiving an EoM message from a train which is completely located inside an Active Shunting Area, then the L3 Trackside shall remove the Track Status Area associated with this train.

Rationale:

For a train completely within an Active Shunting Area, protection after EoM will be provided by the Unknown area associated with this Active Shunting Area.

Guidance:

For a train whose Train Location is fully inside an Active Shunting Area when it reports EoM, the Occupied area corresponding to the Train Location is removed but no additional area of Unknown needs to be created, since the train is already in an Unknown area and the L3 Trackside will not know where the train moves to while in SH mode.

Operational Rules: None

Engineering Rules: None

REQ-EoM-2	Mandatory	[X2R3 D4.2: REQ-EoM-3]
-----------	-----------	------------------------

When the L3 Trackside receives an EoM message, and the reported train speed is not zero, then the L3 Trackside shall extend the Track Status Area associated with the train to the end of the Reserved Status Area allocated to this train.

Rationale:

If the train is still moving when the EoM message is sent, the train will move beyond the reported location after EoM, so this area should be protected.

Guidance:

This requirement applies in the situation where the Driver closes the desk whilst the train is still moving, for example on approach to a station. Closing the desk whilst the train is moving is not normal operation, but nevertheless this requirement is included to cover this situation.

Operational Rules: None

Engineering Rules: None

---



---

REQ-EoM-3	Mandatory	[X2R3 D4.2: REQ-EoM-3]
-----------	-----------	------------------------

---



---

When the L3 Trackside receives an EoM message, then the L3 Trackside shall remove any Reserved Status Area allocated to this train, after having extended the Track Status Area associated with the train, if required.

**Rationale:**

After performing EoM, the train can no longer receive authorisations to move from the L3 Trackside, and so it is no longer necessary to keep a Reserved Status Area allocated to the train.

**Guidance:**

See REQ-EoM-2 for the extending of the Track Status Area associated with the train.

After performing EoM, the train will still be able to be moved in Shunting Mode.

Operational Rules: None

Engineering Rules: None

---



---

REQ-EoM-4	Mandatory	[X2R3 D4.2: REQ-EoM-4]
-----------	-----------	------------------------

---



---

The L3 Trackside shall be able to cope with differences in the confidence interval provided in the position report of a train that reported EoM even when related to the same train position.

**Rationale:**

This is due to an ambiguity in the ETCS specifications around how to calculate the train location accuracy when linking information is deleted due to the change to SB mode.

**Guidance:**

This issue is the subject of CR1318 in the ERA CCM Process [CRProcess]. The L3 Trackside must be able to deal with On-boards which have not applied the solution to CR1318.

Operational Rules: None

Engineering Rules: None

## 3.16 Loss of Train Integrity

### 3.16.1 Introduction

Following Loss of Train Integrity reported by a train, the Track Status Area for the train will change to be an Unknown Track Status Area.

The L3 Trackside considers that the train integrity is lost if:

- Train report is received with Train Integrity Lost
- Expiry of the Integrity Wait Timer
- Receipt of new Validated Train Data with a different Train Length

If Train Integrity is restored, then if the train length is unchanged, the Track Status Area for the train will change to be an Occupied Track Status Area, based on the new Train Position Report.

If Train Integrity is not restored, then the Track Status Area for the train will be maintained as an Unknown Track Status Area, and it will need to be cleared by some other methods.

### 3.16.2 Requirements

REQ-LossTI-1	Mandatory	[X2R3 D4.2: REQ-LossTI-1]
--------------	-----------	---------------------------

When receiving a position report from a train with the information 'Train integrity lost', the L3 Trackside shall consider that the Train Integrity is lost.

**Rationale:**

Loss of Integrity is a degraded mode of operation that the L3 Trackside must protect and attempt to recover from.

**Guidance:**

None.

Operational Rules: None

Engineering Rules: None

REQ-LossTI-2	Mandatory	[X2R3 D4.2: REQ-LossTI-2]
--------------	-----------	---------------------------

When the L3 Trackside considers that the integrity is lost for a train, the L3 Trackside shall change the Track Status Area associated with this train to Unknown and Sweepable.

**Rationale:**

This is to protect the rear end of the train and other trains from collision. Once the Unknown area is established, recovery mechanisms can be applied such as sweeping etc.

**Guidance:**

In this situation, the Track Status for the Train Location of the train changes to Unknown. The Train Location is updated by other requirements, changing the front end from the information in the position report while the rear end is maintained.

The L3 Trackside considers that Train Integrity is lost for a train if not receiving a position report with 'Train integrity confirmed by external device' for a configurable time, or if receiving new Validated Train Data.

Operational Rules: None

Engineering Rules: None

---

---

**REQ-LossTI-3****Mandatory****[X2R3 D4.2: REQ-LossTI-3]**

---

---

When the L3 Trackside considers that the Train Integrity is lost for a train, the L3 Trackside shall react as configured.

**Rationale:**

Loss of Integrity is a degraded mode of operation that the L3 Trackside must protect and attempt to recover from.

**Guidance:**

A project could decide for the L3 Trackside to have different reactions according to whether it is a reported loss of integrity or an assumed loss of integrity (expiry of Integrity Wait Timer or receiving new Validated Train Data).

The reaction taken by the L3 Trackside will depend on application specific requirements. The following non-exhaustive list gives some examples:

- Cause the train to Trip
- Create an additional margin behind the train
- The Movement Authority may be shortened/updated
- Prevent further extension of the Movement Authority unless authorised by the Dispatcher
- Alert the Dispatcher

Alternatively, the L3 Trackside could be configured to take no action.

Note that the first option (tripping the train) could result in a Hazard whereby if a train is tripped in a Reversing Area it would be unable to reverse.

It is important to note that a reported loss of Integrity may be part of an intentional splitting operation, and so any reaction taken by the L3 Trackside needs to balance safety with operational performance. In order for the L3 Trackside to distinguish between intentional loss of integrity (during splitting) and unintentional, additional, application specific, information could be used. This could include for example: The reported speed of the train, the location where the loss of integrity occurs. Note that if the L3 Trackside is not configured to distinguish between an intentional and unintentional Loss of Integrity, and the reaction to a Loss of Integrity is quite severe (e.g. sending of a UES) this could have an impact on operations.

Some L3 Tracksides may be configured to receive input from the TMS, notifying them of the expected Splitting operation occurring in a certain area. This could be used by the L3 Trackside to determine what reaction to take at a reported Loss of Integrity. The configuration of this is project specific and it cannot be assumed that all L3 Trackside have this functionality.

[In addition to a configurable reaction for the L3 Trackside, a reaction for the ETCS On-Board could also be configured. This reaction could be managed using](#)

National Values in the same way as supervision of safe radio connections. This function would require a change to current ETCS specifications [BL3 R2].]

In most cases, when Train Integrity is lost, the rolling stock will apply the brakes.

Operational Rules: OPE-LevelTrans-2

Engineering Rules: ENG-LossTI-3, ENG-LossTI-4

---



---

REQ-LossTI-4	Optional	[X2R3 D4.2: REQ-LossTI-4]
--------------	----------	---------------------------

---



---

The L3 Trackside shall consider the Train Integrity as lost when 'No train integrity information' is reported longer than a configurable time (Integrity Wait Timer).

Rationale:

This is to implement a reaction in case 'No train integrity information' is reported for a long period of time.

Guidance:

Once Train Integrity is considered Lost by the L3 Trackside, the mechanism in REQ-LossTI-2 and REQ-LossTI-3 is applied.

It is application specific whether to implement this function. The timer will have a special value that means the function is disabled.

Note that using this timer the Driver will not be aware of the train Integrity being treated as Lost by the L3 Trackside and as such cannot be expected to react in any manner.

If the L3 Trackside is configured not to accept Train Integrity confirmed by Driver, and Train Integrity confirmed by Driver is reported, then the L3 Trackside will treat this as "No train integrity information".

Projects which use the optional Integrity Wait Timer should consider suspending it for trains in RV mode as there is no additional reaction, see REQ-Rev-3.

There is no specific relation between the length of the Mute Timer and the Integrity Wait timer.

Operational Rules: None

Engineering Rules: ENG-LossTI-1

---



---

REQ-LossTI-5	Optional	[X2R3 D4.2: REQ-LossTI-5]
--------------	----------	---------------------------

---



---

When the Integrity Wait Timer is configured, the L3 Trackside shall start/restart it with every message from the train with the information 'Train integrity confirmed by external device'.

**Rationale:**

This is for the L3 Trackside to implement an appropriate reaction in case a train does not send a position report with integrity confirmed by external device within the configured time.

**Guidance:**

The L3 Trackside does not start/restart the Integrity Wait Timer when driver confirms integrity.

It is application specific whether to implement the Integrity Wait Timer.

Operational Rules: None

Engineering Rules: ENG-LossTI-1

---

REQ-LossTI-6	Proposal	[X2R3 D4.2: REQ-LossTI-7]
--------------	----------	---------------------------

---

After a loss of integrity, the driver shall be made aware of the situation via an indication in the cab.

**Rationale:**

This is to inform the driver that there is a loss of integrity. In this way, Driver can take appropriate measures according to operational procedures defined.

**Guidance:**

As TIMS is a separate system to the ETCS On-Board, there is opportunity to display the status of Train Integrity derived by the TIMS equipment to the driver through alternative means e.g. through a separate indication in the cab.

The TIMS information could be displayed to the driver via the DMI, however this implies a change in the current ETCS specifications [BL3 R2].

Operational Rules: OPE-LossTI-2

Engineering Rules: None

---

REQ-LossTI-7	Mandatory	[X2R3 D4.2: REQ-LossTI-10]
--------------	-----------	----------------------------

---

If the L3 Trackside receives Validated Train Data for a train with a train length different from previously reported within the same communication session, then the L3 Trackside shall consider the train as having lost Integrity.

**Rationale:**

If the train reports loss of Train Integrity as a result of joining or splitting, then this will already result in the Track Status becoming Unknown. This requirement is to catch the situation where the new train length is received before the loss of Train Integrity.

**Guidance:**

When new train data is entered, the ETCS on-board will not confirm Train Integrity until the new train data is acknowledged by the L3 Trackside. This behaviour is as defined in Change Request 940 [CR940].

Operational Rules: None

Engineering Rules: None

## 3.17 Level Transition

### 3.17.1 Introduction

Level Transition functionality is performed in the same way as in L2. However, operating in L3 brings additional challenges, in particular due to the lack of TTD. The issue to be solved in L3 is related to:

- the reception of a position report which allows the L3 Trackside to determine that the CRE is beyond the border for trains leaving the L3 Area, and
- the detection of possible non-communicating trains that attempt to enter the L3 area.

### 3.17.2 Requirements

REQ-LevelTrans-1	Mandatory	[X2R3 D4.2: REQ-LevelTrans-1]
------------------	-----------	-------------------------------

The L3 Trackside shall respond to the detection of non-communicating trains about to enter the L3 area.

**Rationale:**

This is to prevent a train from entering the L3 area unnoticed by the L3 Trackside.

**Guidance:**

This can be done by scheme engineering, such as a short section of TTD at the border or other means that are application specific.

Operational Rules: None

Engineering Rules: ENG-LevelTrans-1

REQ-LevelTrans-2	Mandatory	[New]
------------------	-----------	-------

The L3 Trackside shall always accept a train which is arriving at a transition boundary.

**Rationale:**

Regardless of if a train has an invalid/unknown position, the L3 Trackside shall accept and maintain a connection. For a train reporting a valid position, the L3 Trackside can determine whether or not this is within the Area of Control of the L3 Trackside. This requirement is to avoid hazards such as having a Ghost Train moving in the L3 area.



**Guidance:**

It could be configured to eventually disconnect the train after a timeout. Alternatively, the TMS could request the L3 Trackside to disconnect the communication if the train is not within its area of control.

Operational Rules: None

Engineering Rules: None

---

REQ-LevelTrans-3	Mandatory	[X2R3 D4.2: REQ-LevelTrans-2]
------------------	-----------	-------------------------------

---

For a train that has been authorised to leave the L3 Area, the L3 Trackside shall maintain the communication session with a train reporting a position with an LRBG which is not known to the L3 Trackside, while the previously established CRE of this train is still located in the L3 Area, or until the L3 Trackside decides that it is suitable to terminate the session with this train, or until requested by the TMS to terminate the session with this train.

**Rationale:**

This is to avoid the need for creating an Unknown Track Status Area from the last CRE to the border when a train fails to confirm integrity after having left the L3 Area.

**Guidance:**

This could occur during a Level Transition out of the L3 Area or a Handover when the train reports a position from an unknown LRBG but the CRE is still inside the L3 area or the Handing Over L3 Trackside area.

Having enough Balise Groups known by L3 Trackside in these areas could mitigate the issue. Furthermore, the presence of TTD at the L3 Area boundary could be used as a mitigation. If the problem persists, each specific application has to decide when it is considered safe to disconnect the train taking into account the possible Unknown Track Status Area that has to be created.

This Requirement is about when to terminate the communication session with a train leaving the L3 Area. If a train is reporting a position with an LRBG which is not known to the L3 Trackside, then the CRE of this train will not be updated. If the CRE is still within the L3 Area, then some other mechanism is required to determine when to terminate the communication session.

Operational Rules: None

Engineering Rules: None

## 3.18 Trackside Initialisation

### 3.18.1 Introduction

This section includes requirements associated with starting or restarting the L3 Trackside system. When a Trackside initialisation is needed, it is likely that some subsystems also need to be restarted.

In order to provide a safe initialisation, the L3 Trackside has to start in the most restrictive state. This means that there must be a process in which the L3 Trackside can identify those parts of the area that can be considered Clear. For that purpose, in an ETCS Level 3 system without TTD, it will be advantageous for the L3 Trackside to effectively manage stored information to accelerate the initialisation and capture the state of the railway. Without such methods, the L3 Trackside would have to resort to sweeping the entire Area of Control.

This section details the functionality when an entire Area of Control is initialised due to the L3 Trackside being restarted. To take individual areas out of action (such as a section of line between two stations) the dispatcher can utilise the functionality in section 3.2.2.5 to create an Unknown Track Status Area, and utilise existing L2 functionality such as Track Possession Reminders where necessary.

### 3.18.2 Requirements

REQ-TrackInit-1	Mandatory	[X2R3 D4.2: REQ-TrackInit-1]
-----------------	-----------	------------------------------

The L3 Trackside shall consider the entire L3 Area of Control to be a Sweepable Unknown Track Status Area when the L3 Trackside initialisation starts.

Rationale:

This is to start with the most restrictive state.

Guidance:

Sweepable Unknown can be cleared by TTD, where TTD are used.

Operational Rules: None

Engineering Rules: None

REQ-TrackInit-2	Mandatory	[X2R3 D4.2: REQ-TrackInit-2]
-----------------	-----------	------------------------------

The L3 Trackside shall utilise valid Stored Information to enable faster initialisation.

Rationale:

Historic information on the state of the railway from before the L3 Trackside was restarted can enhance the Initialisation process.

Guidance:

The location of all trains in communication prior to the restart, along with the extent of any MAs issued will be valuable information to be utilised.

The validity of the information used must be carefully considered, as if the L3 Trackside has been offline for some time the State of the Railway is likely to have changed.

Criteria for considering Stored information as valid are project dependent e.g. during Trackside Initialisation, if the time passed is smaller than a configured value.

Operational Rules: None

Engineering Rules: ENG-TrackInit-1

---



---

REQ-TrackInit-3	Mandatory	[X2R3 D4.2: REQ-TrackInit-3]
-----------------	-----------	------------------------------

---



---

The L3 Trackside shall, if configured, provide a means for the person responsible for the Trackside Initialisation to confirm that the procedure is completed.

Rationale:

If Stored Information is not valid, the person in charge of initialising the L3 Trackside has to confirm when the procedure is completed. They have the authority to confirm that all the obstacles on the railway are known to the L3 Trackside.

Guidance:

If Stored information is used to initialise the L3 Trackside, this confirmation is not needed and it is project specific to implement it.

Operational Rules: OPE-TrackInit-4

Engineering Rules: ENG-TrackInit-2

---



---

REQ-TrackInit-4	Mandatory	[X2R3 D4.2: REQ-TrackInit-4]
-----------------	-----------	------------------------------

---



---

The L3 Trackside shall clear the remaining Unknown Track Status Areas created at the start of the Trackside Initialisation procedure and consider the Trackside Initialisation process as completed either:

- upon receiving confirmation of completion of the Initialisation procedure from the responsible person, OR
- after Stored Information has been used and confirmation from the responsible person is not required

Rationale:

During Initialisation, the L3 Trackside will create Occupied areas for trains in communication, create Unknown areas based on stored data, and accept any additional Unknown areas created at the request of the TMS. Once the procedure is completed, the remaining track can be considered clear.

Guidance:

This step in the Trackside Initialisation process results in the removal of the initial Unknown area created at the start of the process. How this is done is project specific.

Operational Rules: None

Engineering Rules: None

---



---

REQ-TrackInit-5	Mandatory	[X2R3 D4.2: REQ-TrackInit-5]
-----------------	-----------	------------------------------

---



---

The L3 Trackside shall only create Reserved Status Areas for trains, and send Movement Authorities to trains in the Area of Control, after the Trackside Initialisation procedure has been completed.

Rationale:

This is to prevent the L3 Trackside authorising train movements during the Initialisation procedure, which could be hazardous when trying to identify the state of the track.

Guidance:

None.

Operational Rules:     None

Engineering Rules:     None

## 3.19 Handover

### 3.19.1 Introduction

The Handover procedure is the same as in L2 except for termination of the communication session with the Handing Over L3 Trackside, as introduced by the solution to Change Request 940 [CR940].

Handover with only one mobile is a degraded situation. A project specific solution will be required to determine that a train has left the Area of Control of the Handing Over L3 Trackside.

### 3.19.2 Requirements

---



---

REQ-HO-1	Mandatory	[X2R3 D4.2: REQ-HO-1]
----------	-----------	-----------------------

---



---

When acting as an Accepting L3 Trackside, the L3 Trackside shall only send Route Related Information message to an adjacent ETCS Trackside System when this is allocated to a Reserved Status Area.

Rationale:

This is because the adjacent ETCS Trackside System can use the RRI to send an MA covering this area.

Guidance:

There may need to be a mechanism to remove the Reserved Status Area if the train does not arrive in the Accepting L3 Trackside.

In case there is not yet a Reserved Status Area established in the Accepting RBC, it may still reply with an RRI with zero distance.

Operational Rules:     None

Engineering Rules:     None

---



---

REQ-HO-2	Mandatory	[X2R3 D4.2: REQ-HO-2]
----------	-----------	-----------------------

---

When the Handing Over L3 Trackside receives a position report and detects that the complete train has crossed the border, it shall send a session termination order to the ETCS On-Board equipment.

**Rationale:**

This is to allow the Handing Over L3 Trackside to consider the track clear in the area in rear of the border.

**Guidance:**

The L3 Trackside can detect that the complete train has crossed the border if it receives a train position report with train integrity confirmed, which places the Confirmed Rear End beyond the border.

In degraded situations, for example:

- A train which is not able to confirm train integrity during the handover
- A train with only one working mobile

projects may decide to use other means to detect that the complete train has crossed the border, for example using TTD.

Operational Rules:       None

Engineering Rules:       ENG-Generic-14

---



---

REQ-HO-3	Mandatory	[X2R3 D4.2: REQ-HO-3]
----------	-----------	-----------------------

---

If the L3 Trackside considers the communication session is terminated with a train approaching the L3 Area, then the L3 Trackside shall set the Track Status to Unknown for any area that is Reserved for this train, unless this area is already Unknown.

**Rationale:**

If a train is approaching a L3 area and the communication session is considered terminated, the L3 Trackside will no longer know its location nor will be able to determine whether the train will stop before the border location or into its Area of Control. As such, the area that is Reserved for this train needs to change to Unknown to protect the train.

**Guidance:**

This requirement covers both entry into an L3 area at a Transition border and Handover between two L3 Tracksides.

For Handovers, if there is no loss of communication between L3 Tracksides, projects may implement different solutions, i.e. may cancel the on-going Handover or decide to remove the Unknown area and create a new Reserved Status Area when a new message indicating that the Handover is still ongoing is received by the Accepting L3 Trackside.

When there is no communication between the L3 Tracksides or in a Level Transition, the Accepting L3 Trackside has to create a new Unknown area to ensure that the previously Reserved Status Area is not used by another train.

For a train with its ETCS On-board reporting FS, the Unknown area is needed as the Accepting L3 Trackside cannot be sure where this train will stop before the border.

Criteria for the L3 Trackside to establish whether the train is able to stop before the border are project specific. Similarly, it is left to projects to decide the criteria for when a train is to be considered approaching the L3 area.

Operational Rules: None

Engineering Rules: None

## 3.20 Shunting movement

### 3.20.1 Introduction

A challenge for an ETCS Level 3 system without TTD is to manage shunting as the trains disconnect while in SH mode. The best way to handle this is to only allow shunting in predefined areas and consider an Active Shunting Area as having Track Status Unknown. In addition, for systems with no general use of TTD, the boundaries of a Shunting Area could have some TTD installed for passage detection. For systems with a general use of TTD, the supervision of shunting movements is not different from ETCS Level 2.

Stored information is used to provide a quick recovery after shunting.

Two different types of Shunting Areas are foreseen:

- Permanent Shunting Areas: where there is a predefined area in the track dedicated to shunting.
- Temporary Shunting Areas: where there are predefined Shunting Areas which can be activated or deactivated with a request to the L3 Trackside.

A train transitioning to shunting (SH) mode is considered as an EoM by the L3 Trackside. As such, some requirements in section 3.15 apply to this situation.

It is not foreseen to authorise trains to enter shunting using SH mode profile for a further location, because it can be difficult to decide where it should start. If the SH mode profile starts too early, the train might change to SH mode before being able to confirm integrity when completely inside the Active Shunting Area, which would result in an Unknown Track Status Area adjacent to the Shunting Area. To avoid this, the train may need to move further into the Shunting Area before changing to SH mode than what is operationally feasible. However, projects may decide to use this option and it could anyway be useful for entering a Permanent Shunting Area. It will also help if there is some TTD section(s) to detect passage into or out of a Shunting Area, as this can then be used to remove an Unknown Track Status area created when changing to SH mode while not completely inside the Shunting Area.

The Active Shunting Area has to store the train length of all the trains in the area. When a train enters into an Active Shunting Area its length is not added to the Unknown Area associated to the Active Shunting Area until the communication is terminated.

### 3.20.2 Requirements

REQ-SH-1	Optional	[X2R3 D4.2: REQ-SH-2]
----------	----------	-----------------------

On request from the TMS, the L3 Trackside shall be able to activate and deactivate a Temporary Shunting Area.

**Rationale:**

If Temporary Shunting Areas are configured, then the TMS must have the possibility to activate and deactivate them.

**Guidance:**

Activation and deactivation of Temporary Shunting Areas by the L3 Trackside may be subject to project specific conditions.

Possible checks before activating a Temporary Shunting Area may include:

- Trains intended to perform shunting are stationary and their location is fully inside the inactive Temporary Shunting Area.
- Trains not intended to perform shunting but are authorised to pass through the area are clear of the inactive Temporary Shunting Area before it is activated

For a train whose Train Location is not fully inside the inactive Temporary Shunting Area, the L3 Trackside could still activate the Temporary Shunting Area and manage overlapping Unknown areas.

Possible checks before deactivating a Temporary Shunting Area may include:

- All shunting activities have stopped.
- Trains that were shunting have re-established a communication session with the L3 Trackside.
- The Train Length of the trains that were shunting have been accounted for by train(s) in communication with the L3 Trackside.

These are examples of what could be checked before activating or deactivating a Temporary Shunting Area. The checks will be project specific.

Operational Rules: OPE-SH-1; OPE-SH-2

Engineering Rules: ENG-SH-1

REQ-SH-2	Mandatory	[X2R3 D4.2: REQ-SH-3]
----------	-----------	-----------------------

The L3 Trackside shall consider the Track Status of an Active Shunting Area to be Unknown and Non-Sweepable.

**Rationale:**

While shunting, the ETCS On-board is not connected to the L3 Trackside and therefore any train movements in SH mode are unknown to the L3 Trackside. The Unknown is flagged Non-Sweepable so that it is not removed by a sweeping train.

**Guidance:**

This applies to Permanent and Temporary Shunting Areas.

Operational Rules: None

Engineering Rules: None

---



---

REQ-SH-3	Mandatory	[New]
----------	-----------	-------

---

When a Temporary Shunting Area is activated, the L3 Trackside shall remove all (parts of) Sweepable Unknown Track Status Areas inside this Shunting Area and any Recorded Train Length in such areas shall be added to the Track Status Area associated with the activated Shunting Area.

Rationale:

This is to keep track of the total length of vehicles and/or waggon being inside an Activated Temporary Shunting Area.

Guidance:

This applies to any part of a Sweepable Unknown Track Status Area inside an Activated Temporary Shunting Area, while other parts of such an area are not affected.

In case there is a Recorded Train Length for a Sweepable Unknown Track Status Areas being partly removed (“swept”) by the activation of a Temporary Shunting Area, this results in adding the Recorded Train Length to the Track Status Area associated with the Shunting Area, while the length is also still stored with the remaining part of that area. This is the same principle as if a Sweepable Unknown Track Status Area is split by a clear TTD section, i.e. a Recorded Train Length is stored for both parts as there is no way to know how to divide it between them.

Operational Rules: None

Engineering Rules: None

---



---

REQ-SH-4	Mandatory	[New]
----------	-----------	-------

---

The L3 Trackside shall store the total Train Length of all trains inside an Activated Temporary Shunting Area.

Rationale:

This is to be able to decide whether the Unknown Track Status Area associated with an active Temporary Shunting Area can be removed after deactivating the Temporary Shunting Area.

Guidance:

The L3 Trackside will need to update the total Train Length of the trains in an Activated Temporary Shunting Area when:

- The Temporary Shunting Area is activated
- A train completely within the Activated Temporary Shunting Area performs EoM
- A train within the Activated Temporary Shunting Area confirms Train Integrity after performing Start of Mission



Operational Rules: None  
 Engineering Rules: None

---



---

REQ-SH-5	Mandatory	[New]
----------	-----------	-------

---

When the L3 Trackside deactivates a Temporary Shunting Area with all the Train Length stored for this area accounted for by one or more trains, then the Unknown Track Status Area associated with the Temporary Shunting Area shall be removed.

**Rationale:**

When a Temporary Shunting Area has been deactivated and there is no Train Length stored for the associated Unknown Track Status Area, then it is safe to remove the Unknown Track Status Area.

**Guidance:**

This may happen when deactivating the Temporary Shunting Area, or afterwards as trains reconnect and establish a Train Location.

In case there is an additional Active Shunting Area or an uncontrolled area adjacent to the Temporary Shunting Area to be deactivated where trains not known to L3 Trackside might have entered then it is up to the project to implement additional checks to deactivate the Temporary Shunting Area.

Operational Rules: OPE-SH-2  
 Engineering Rules: None

---



---

REQ-SH-6	Mandatory	[New]
----------	-----------	-------

---

When the L3 Trackside deactivates a Temporary Shunting Area with some Train Length stored for this area not accounted for, then the L3 Trackside shall change the Unknown Track Status Area associated with the Temporary Shunting Area to become Sweepable.

**Rationale:**

When a Temporary Shunting Area has been deactivated but the Unknown Track Status Area remains it must be possible to sweep this Unknown area.

**Guidance:**

When the length of all shunting trains is not accounted for when a Temporary Shunting Area is deactivated, the Unknown Track Status Area must remain, but it can now be swept by authorised train movements. It may also be recovered after being deactivated by train(s) establishing their Train Location accounting for all the train length associated with the Unknown Track Status Area. The Train Length associated with this Unknown Track Status Area is still maintained.

Operational Rules: None  
 Engineering Rules: None

---

---

**REQ-SH-7****Optional****[New]**

---

---

The L3 Trackside shall be able to send a text message to the train when the L3 Trackside determines that train has completely entered an Active Shunting Area.

**Rationale:**

This will reduce the possibility of a Driver requesting Shunting mode before it is fully within the Shunting Area.

**Guidance:**

The implementation of this will be project specific.

The L3 Trackside may also send a text message when the front of the train enters the Active Shunting Area.

Operational Rules:      None

Engineering Rules:      None

## 3.21 Traffic Management System interface

### 3.21.1 Introduction

There are several sections in this specification where there are requirements for output of information to the Traffic Management System (TMS), and for interaction between the L3 Trackside and the TMS.

The exported requirements for the TMS are included below. The following tables summarise the interactions between the TMS and L3 Trackside and the associated requirements. Section 3.21.2 details a single exported requirement for the interface between the Dispatcher and the TMS.

<b>L3 Trackside → TMS</b>	
<b>Indications</b>	<b>Requirement ID</b>
Report the Train Location and status for all trains within the entire L3 Area	REQ-TrainLoc-3
Report the Track Status of the entire L3 Area	REQ-TrackStatus-25
Report the Reserved Status of the entire L3 Area	REQ-Reserved-11
Report all Movement Authorities in the entire L3 Area	REQ-MA-5
<b>Alarms and Notifications</b>	<b>Requirement ID</b>
Alert about a train reporting an invalid or unknown position	REQ-SoM-2
Alert if an approximate position assigned to a train reporting an invalid or unknown position is outside an existing Unknown Track Status Area	REQ-SoM-5
Alert if configured, if a train terminates its communication session without having sent Validated Train Data	REQ-SoM-7
Alert if configured, if Validated Train Data has not been received for a train after a defined timeout	REQ-SoM-8
Alert if a train reports a position that is unexpected or in conflict with other train movements	REQ-TrainLoc-13
Alert if receiving Validated Train Data from a train with a position within an Unknown Track Status Area, for which the train length now reported by the train is greater than the Recorded Train Length stored with the Unknown Track Status Area	REQ-TrackStatus-8
Notify if a train does not leave a Radio Hole as expected	REQ-RadioHole-7
Alert if configured, if a decision is required before issuing a Movement Authority to a train when part of the Reserved Status Area has become Unknown or Occupied ahead of the current authorisation for that train	REQ-MA-7 REQ-MA-8
Alert if configured, if the L3 Trackside considers that Train Integrity is lost for a train	REQ-LossTI-3

<b>TMS → L3 Trackside</b>	
<b>Commands</b>	<b>Requirement ID</b>
Create Sweepable Unknown Track Status Areas	REQ-TrackStatus-22
Create Non-Sweepable Unknown Track Status Areas	REQ-TrackStatus-23
Remove, reduce or extend Unknown Track Status Areas	REQ-TrackStatus-24
Establish or extend Reserved Status Areas	REQ-Reserved-1 REQ-Reserved-5
Reduce or remove Reserved Status Areas	REQ-Reserved-9
Authorise removal of Unknown Track Status Areas caused by faulty TTD	REQ-TTD-11
Move points within Unknown Track Status Area by emergency procedure	REQ-PTS-3
Provide an estimated location for a train to the L3 Trackside	REQ-SoM-4
Request termination of communication session with a train	REQ-SoM-6
If configured, Authorise Sweeping of Unknown Track Status Areas	REQ-MA-7
Activate and deactivate Temporary EoA Exclusion Areas	REQ-EoAExclusionArea-2
Activate and deactivate Temporary Radio Holes	REQ-RadioHole-1
Activate and deactivate Temporary Shunting Areas	REQ-SH-1

**Table 10: TMS associated requirements**

### 3.21.2 Requirements

REQ-TMS-1	Mandatory	[X2R3 D4.2: REQ-TMS-1]
-----------	-----------	------------------------

The TMS shall provide means for the Dispatcher to assign a position to a train that is reporting unknown or invalid position.

**Rationale:**

This is to allow the Dispatcher to locate the train on the track after a specific operational procedure. Whilst this functionality is available at L2, it is different at L3 with Moving Block as the train can be located anywhere in the L3 Area and not in a specific block.

**Guidance:**

The Dispatcher may need to contact the Driver and determine an estimated location for the train.

How the Dispatcher enters the location in the TMS is project specific, but it must be within an existing Sweepable Unknown Track Status Area to be accepted by the L3 Trackside.

Operational Rules: OPE-SoM-4

Engineering Rules: None